

# SKYLINE





# SKYLINE

CONTEMPORANEI



# LASTRE IN GRES PORCELLANATO PRESSATE A SECCO

Dry-pressed porcelain stoneware slabs.  
Dalles en grès cérame pressées à sec.  
Trockengepresste Platten aus Feinsteinzeug.  
Planchas en gres porcelánico prensadas en seco.  
Керамогранитные плиты сухого прессования.  
干压陶瓷砖。

**Spessore. 6 mm . 10 mm . 10 mm R11 . 12 mm\* . 20 mm R11**

Thickness.

Epaisseur.

Starke.

Espesor.

Толщина.

厚度。

## I N D E X

design mood	02
colours and sizes	04
ambiences	08
products	32
package	49
technical features	54

**Art direction**  
LA FABBRICA S.p.A.

**Stampa**  
Faenza Group S.p.A.

La Fabbrica S.p.A. si riserva di apportare, senza alcun preavviso, le modifiche che riterrà più opportune al fine di migliorare il prodotto. Quanto riportato è da considerarsi indicativo e non esaustivo in riferimento ai colori e alle caratteristiche estetiche dei prodotti.

LA FABBRICA S.p.A. reserves the right to make any changes it deems fit in order to improve the product, without prior notice. All images are provided for illustrative purposes only and other colours and aesthetic features are available.

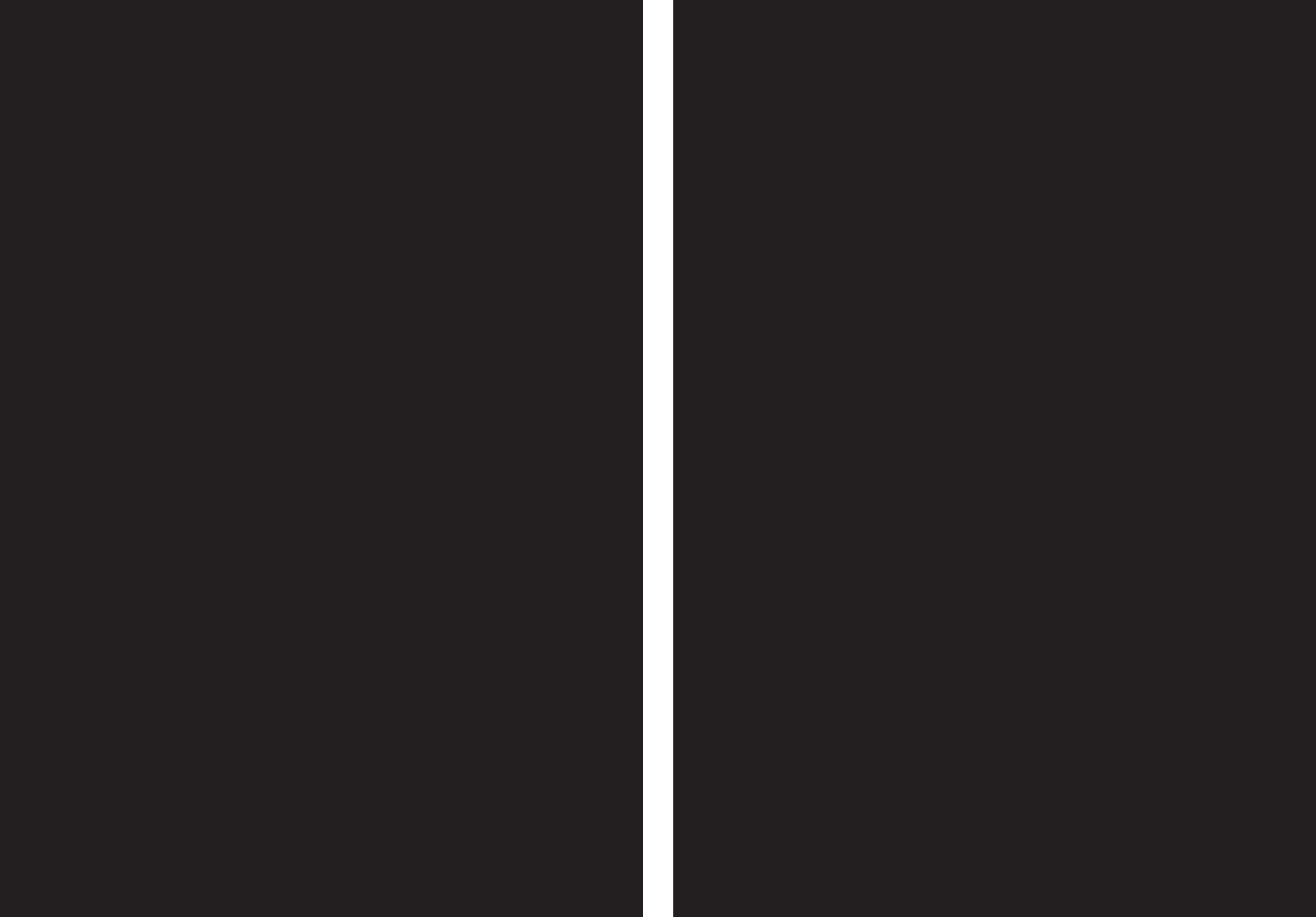

## ABOUT SKYLINE DESIGN MOOD

La rigidità materica del cemento e la sua estetica suggestiva definiscono Skyline, la collezione dei Contemporanei Ava nata dal concept delle aree metropolitane per vestire ambienti in stile urban ma anche quelli dal design minimal.

Le caratteristiche del gres porcellanato rispecchiano le qualità della materia grezza del cemento con le sue texture eterogenee e naturali, stemperate di leggere sfumature su tono che ne addolciscono la sua struttura. Una collezione attuale per chi è alla ricerca di un pizzico di sobria modernità.



The material severity of concrete and its striking design are distinguishing features of Skyline, an Ava Contemporanei collection inspired by cityscapes, ideal for urban-style, even minimalist environments.

Porcelain stoneware reproduces the qualities of concrete raw materials with its assorted, natural textures, whose delicate tonal shading softens its surface. A contemporary collection, for people looking for a touch of sober modernity.

L'aspect rigoureux et l'esthétique suggestive de la matière du béton caractérisent Skyline, la collection née du concept des régions métropolitaines pour habiller les endroits en style urbain aussi bien que ceux au design minimaliste.

Les caractéristiques du grès cérame reflètent les qualités de la matière brute du béton avec ses textures hétérogènes et naturelles, atténuées par de légères nuances ton sur ton qui adoucissent sa structure. Une collection actuelle pour ceux qui sont à la recherche d'une touche de modernité sobre.

Die materielle Strenge des Betons und seine auffällige Ästhetik definieren Skyline, die Kollektion der Zeitgenossen Ava, die aus dem Konzept der Metropolregionen hervorgegangen ist, um Umgebungen im urbanen Stil zu kleiden, aber auch solche mit minimalem Design.

Die Eigenschaften von Feinsteinzeug spiegeln die Eigenschaften des Zementrohstoffs mit seinen heterogenen und natürlichen Texturen wider, die mit hellen Farbtönen verdünnt sind, die seine Struktur weicher machen. Eine aktuelle Kollektion für alle, die eine Prise nüchterner Modernität suchen.

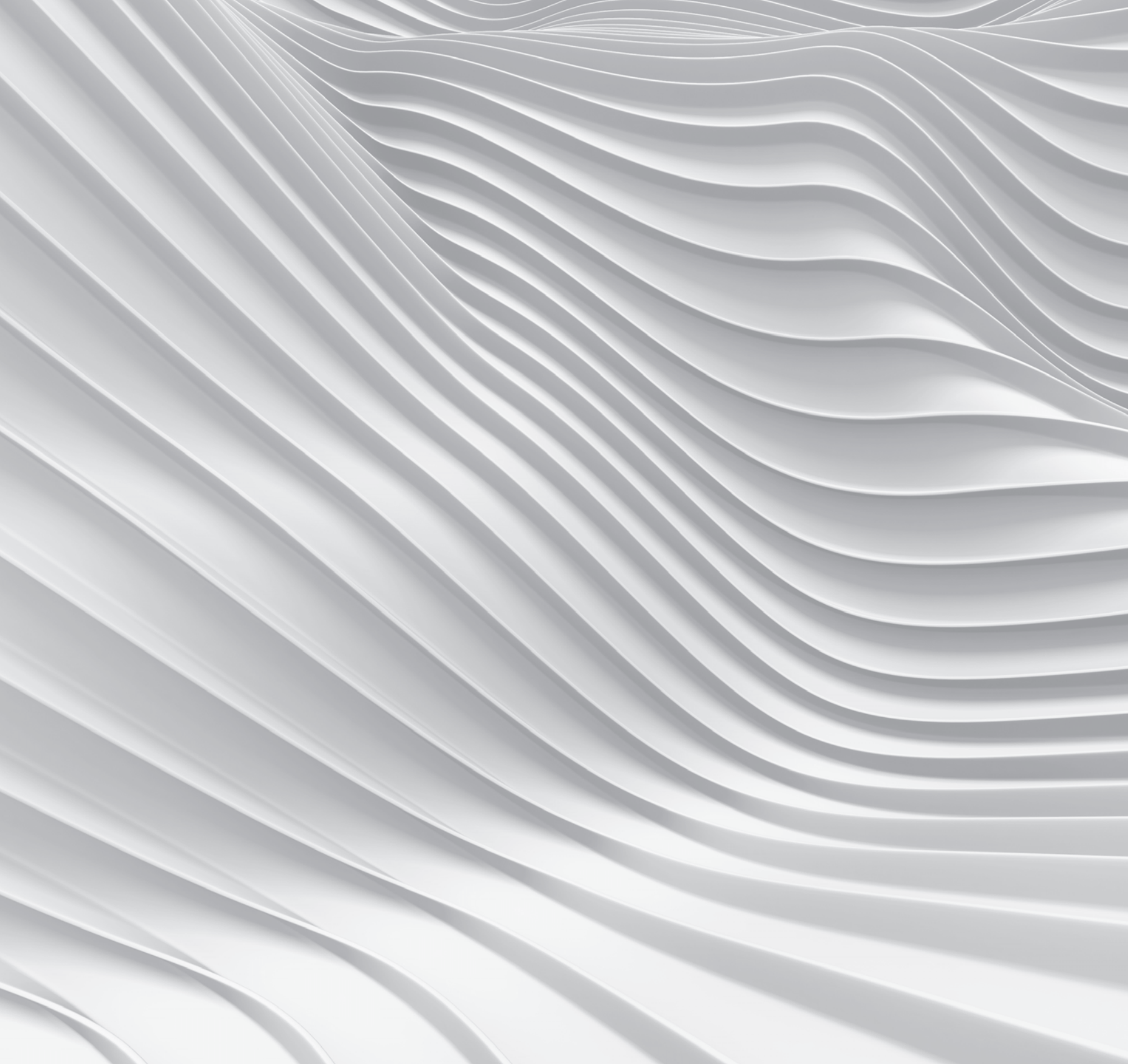

La severidad matérica del cemento y su estética sugestiva definen la colección Skyline. La colección de los 'Contemporanei Ava' que nace del concepto de las áreas metropolitanas para vestir ambientes en estilo urbano, pero también aquellos de diseño minimalista. Las características del gres porcelánico reflejan las cualidades de la materia bruta del cemento con sus texturas heterogéneas y naturales, atenuadas por leves matices sobre el tono que suavizan su estructura. Una colección actual para quienes buscan un toque de sobria modernidad.

Строгость текстуры цемента и ее выразительная эстетика характеризует Skyline, коллекцию Contemporanei Ava, которая создана на основе концепции пространств мегаполиса для отделки помещений в городском и минималистичном стиле. Характеристики керамогранита повторяют свойства цемента, сырого материала с его естественной и неоднородной текстурой, разбавленной легкими оттенками в тон, смягчающими его структуру. Актуальная коллекция для тех, кто хотел бы внести в свои интерьеры нотку строгой современности.

混凝土材料的严谨性和迷人的外观定义了 Skyline，从大都市概念诞生 Contemporanei Ava 系列，用于装饰城市风格的环境，但同时也适用于极简风格的设计。

陶瓷的特性通过复杂但自然的纹理反映出混凝土原材料的品质，在色调上用淡淡的深浅变化调色，从而软化其结构。正是现在那些寻找一丝朴素现代感人们的产品。

## COLOURS AND SIZES

Il look materico della collezione Skyline si sposa alla perfezione con gli ambienti moderni e, allo stesso tempo, può creare uno stacco di stile soft e gradevole.

Il grande formato 324x163 cm in 12 mm, il 320x160 cm e il suo modular system in soli 6 mm di spessore, il 120x60 cm e il 60x60 cm in 10 mm ed il formato 100x100 cm in 10 e 20 mm che arricchisce la collezione anche della sua versione outdoor, sono alcune possibilità nella varietà di gamma di formato che dimostrano la grande versatilità di applicazione di questa peculiare collezione dei Contemporanei. Infinite sono infatti le sue possibilità di utilizzo, dal rivestimento al pavimento per interni ed esterni, ai mobili, tavoli, piani, ante e pareti ventilate.

Il colore, che ricopre in maniera quasi uniforme la superficie del gres, è permeato di un velo tonale caldo che riesce, grazie alla gamma dei due colori scuri come l'antracite e il fumo e dei due caldi, il ghiaccio e il beige, a scaldare anche gli ambienti dal carattere più essenziale.



The material look of Skyline collection fits perfectly with any modern environment and creates a soft and pleasant contrast of style at the same time.

The big size 324x163 cm in 12 mm, the 320x160 size and its modular system in 6 mm, the 120x60 and 60x60 sizes in 10 mm, and the 100x100 size in 10 mm and 20 mm which enriches the collection in its outdoor version. These are just some examples of the wide size range that show the great versatility of applications of this peculiar Contemporanei collection. Its possibilities of use are unlimited, from walls to floors whether indoor or outdoor, to furniture, tables, shelves, doors and ventilated walls.

The colour, which covers the surface of the porcelain stoneware almost uniformly, is dyed with a warm tonal veil and, thanks to two dark colours, such as Antracite and Fumo, and two light colours, such as Ghiaccio and Beige, brings a touch of warmth even to the most essential environment.

El look matérico de la colección Skyline se combina a la perfección con los ambientes modernos y, al mismo tiempo, puede crear un corte de estilo soft y agradable. El formato grande 324x163 cm de 12 mm, el 320x160 cm y su sistema modular de solo 6 mm de espesor, el 120x60 cm y el 60x60 cm de 10 mm y el formato 100x100 cm de 10 y 20 mm enriquecen la colección también en su versión para exteriores. Éstas son algunas de las posibilidades dentro de la gama de formatos que demuestran la extrema versatilidad de aplicación de la singular colección "Contemporanei". Son infinitas las posibilidades de uso, desde el revestimiento hasta el pavimento de interiores y exteriores, pasando por los muebles, mesas, superficies, puertas y paredes ventiladas. El color reviste casi de manera uniforme la superficie del gres y se impregna de un impalpable tono cálido que también consigue, gracias a la gama de colores oscuros como el antracita y el humo y a dos colores claros, el hielo y el beige, calentar aquellos ambientes de carácter esencial.

L'effet matière de la collection Skyline s'harmonise parfaitement avec les ambiances modernes et elle peut créer, en même temps, une touche de style léger et agréable. Le grand format 324x163 en 12 mm, le 320x160 cm et son système modulaire en seulement 6 mm d'épaisseur, le 120x60 cm et le 60x60 cm en 10 mm et le format 100x100 cm en 10 et 20 mm qui enrichit la collection de la finition outdoor, ne représentent que quelques options dans la variété de gamme de formats qui confirment l'énorme flexibilité d'utilisation de cette exclusive collection de "l'Contemporanei". Ses possibilités de mise en œuvre sont en effet infinies : revêtement de murs et de sols, habillage de meubles, tables, plans de travail, portes et façades ventilées. La couleur, qui se répand de façon presque uniforme sur la surface du grès, est imprégnée d'une nuance chaude qui, grâce à la gamme des deux couleurs foncées comme l'antracite et le fumo et des deux teintes chaudes, le ghiaccio et le beige, est capable de réchauffer même les ambiances les plus essentielles.

Фактурность коллекции Skyline идеально сочетается с современными интерьерами и в то же время способна создавать мягкий и приятный стилистический контраст. Крупный формат 324x163 см толщиной 12 мм, 320x160 см и его модульная система толщиной всего лишь 6 мм, 120x60 см и 60x60 см толщиной 10 мм, а также формат 100x100 см толщиной 10 и 20 мм, дополняющий коллекцию также в исполнении для наружных пространств - это только некоторые варианты из всего разнообразия ассортимента форматов, которые отличаются необычайной универсальностью применения этой неповторимой коллекции Contemporanei (Современный дизайн). И действительно, возможности использования плитки из этой коллекции бесконечны: от отделки полов помещений и наружных пространств до мебели, столов, столешниц, створок и вентилируемых фасадов. В цвете, почти равномерно покрывающим поверхность керамогранита, улавливается теплая нотка, которая, благодаря гамме двух темных (антрацит и fumo) и двух светлых (ghiaccio и beige) оттенков, придаст теплоту также более строгим интерьерам.

Der materielle Look der Skyline-Kollektion passt perfekt zu modernen Umgebungen und kann gleichzeitig einen weichen und angenehmen Kontrast des Stils schaffen. Das große Format 324x163 in 12 mm Stärke, das Format 320x160 cm und sein modulares System in nur 6 mm Stärke, das Format 120x60 cm und 60x60 cm sind in 10 mm und das Format 100x100 cm in 10 und 20 mm, somit wird die Kollektion auch bereichert in der Outdoor-Version und es gibt einige Möglichkeiten in den verschiedenen Größenbereichen, die die große Vielseitigkeit der Anwendung dieser besonderen zeitgenossenen Kollektion demonstrieren. Die Verwendungsmöglichkeiten sind unbegrenzt, von der Abdeckung über den Boden für Innen- und Außenbereiche bis hin zu Möbeln, Tischen, Regalen, Türen und belüfteten Wänden. Die Farbe, die die Oberfläche des Feinsteinzeugs nahezu gleichmäßig bedeckt, ist von einem warmen Tonschleier durchdrungen, dank der Bandbreite der beiden dunklen Farben wie Anthrazit und Fumo und der beiden warmen Farben Ghiaccio und Beige, die erfolgreich auch die wichtigsten Umgebungen wärmen.

Skyline系列的材料外观与现代环境完美结合,同时营造出柔和宜人的风格。大规格尺寸,324x163厘米,厚度12毫米;320x160厘米及模块系统厚度仅为6毫米;120x60厘米和60x60厘米,厚度10毫米;以及100x100厘米,厚度10毫米和20毫米,丰富了户外系列品种,提供各种可能的尺寸,体现了这个Contemporanei系列在使用中的多功能性。本系列产品具有无限的可能性,适用范围从墙面到室内外地板,以及家具,桌子,台面,柜门和通风外墙。颜色均匀地覆盖在粗陶表面上,并弥漫着一层温暖的色调,源于两种深色;煤色和烟色,以及两种浅色;冰色和米色,即使是最基础的环境,也能营造温暖氛围。





# SKYLINE

## CONTEMPORANEI

### LASTRE IN GRES PORCELLANATO PRESSATE A SECCO

Dry-pressed porcelain stoneware slabs. Dalles en grès cérame pressées à sec. Trockengepresste Platten aus Feinsteinzeug.

Planchas en gres porcelánico prensadas en seco. Керамогранитные плиты сухого прессования. 干压陶瓷砖.

UNI EN 14411-ISO 13006 appendice C gruppo BIa - UGL

#### SHADE SPECTRUM

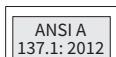
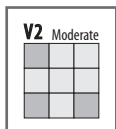

WET DYNAMIC COEFFICIENT OF FRICTION

DCOF ≥ 0,42

SOLO SUPERFICIE NATURALE  
Only Natural Surface

OUTDOOR  
100x100: 10 mm  
100x100: 20 mm

R11  
C

SCIVOLosità  
SLIPPERY GRADE

Spessore.  
Thickness.  
Épaisseur.  
Stärke.  
Espesor.  
Толщина.  
厚度.



○ Lappato e rettificato.

Lappato and rectified.

Lappato et rectifié.

Lappato und kalibriert.

Lappato y rectificado.

Лаппатированный ректифицированный.

亚光和抛光.

□ Naturale e rettificato.

Natural and rectified.

Naturel et rectifié.

Natur Oberfläche und kalibriert.

Natural y rectificado.

Натуральный ректифицированный.

天然和抛光.

■ Naturale.

Natural.

Naturel.

Natur natur.

Natural.

Натуральный.

天然.

■ NAT.

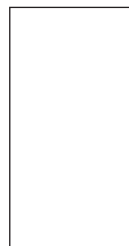

324x163cm

127"x64"

12mm \*

□ NAT. RET.



320x160cm

126"x63"



160x160cm

63"x63"

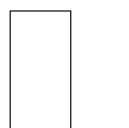

160x80cm

63"x31 1/2"



80x80cm

31 1/2"x31 1/2"

6mm

MODULAR SYSTEM

□ NAT. RET.

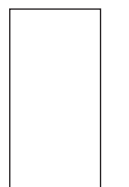

240x120cm

96"x48"



120x120cm

48"x48"

6mm

MODULAR SYSTEM

□ NAT. RET. ○ LAP. RET.



120x60cm

48"x24"

10mm



60x60cm

24"x24"

MODULAR SYSTEM

□ NAT. RET. □ NAT. RET. RII



100x100cm

40"x40"

10mm

□ NAT. RET. RII



100x100cm

40"x40"

20mm

\* Disponibile con ordine minimo di 1.200 m<sup>2</sup>.

Available with minimum order of 1.200 m<sup>2</sup>. Quantité minimale par commande 1200 m<sup>2</sup>.

Erhältlich bei einer Mindestbestellmenge von 1.200 m<sup>2</sup>. Disponible bajo pedido mínimo de 1.200 m<sup>2</sup>. При минимальном заказе от 1200 м<sup>2</sup>. 最少订购1,200平方米.

GHIACCIO

ANTRACITE

FUMO

BEIGE





SKYLINE / floor and wall: antracite 360x120-126"x63" NAT.RET.  
SKYLINE / wall and counter top: ghiaccio 360x120-126"x63" NAT.RET.



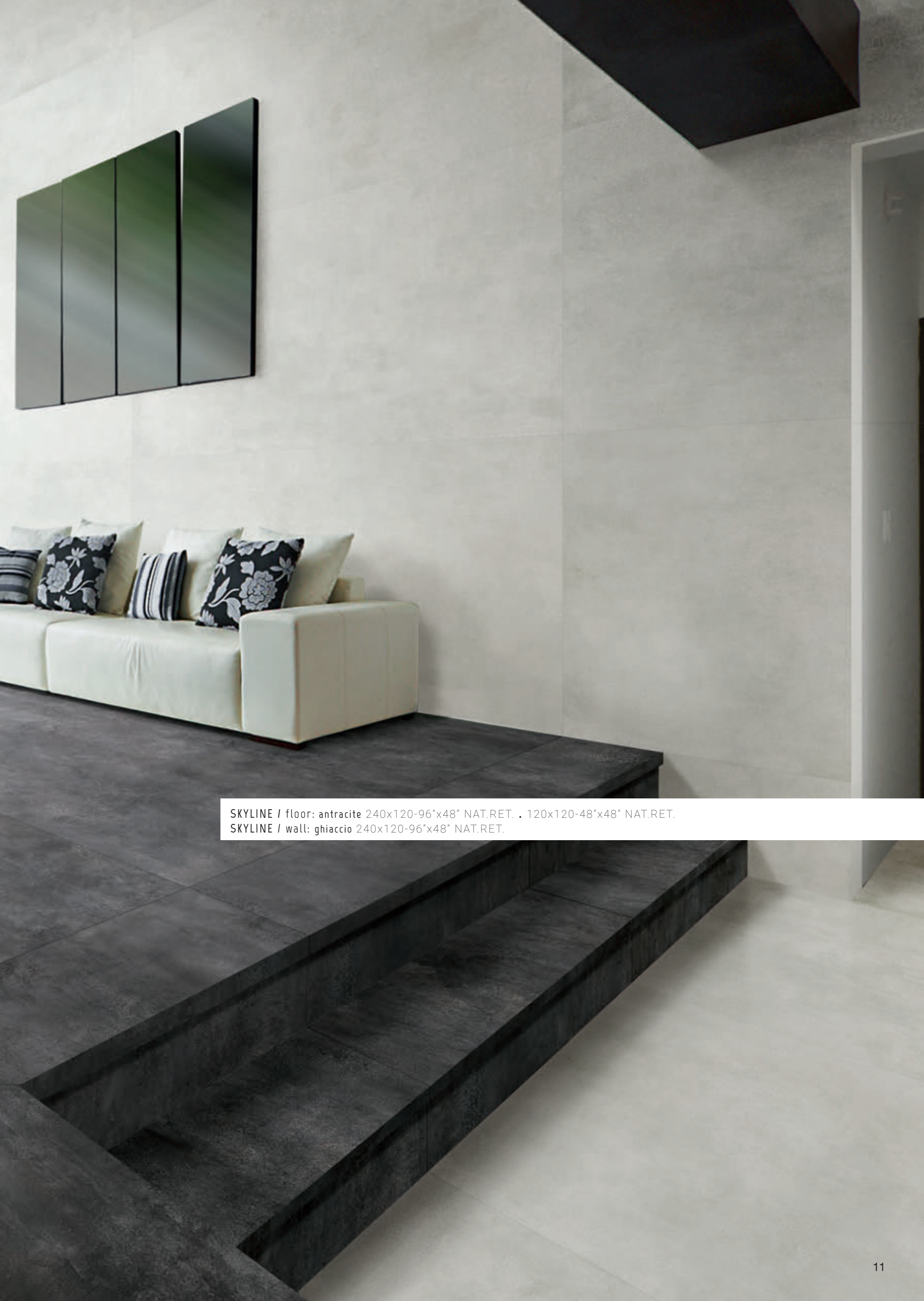

SKYLINE / floor: antracite 240x120-96"x48" NAT.RET. . 120x120-48"x48" NAT.RET.  
SKYLINE / wall: ghiaccio 240x120-96"x48" NAT.RET.





SKYLINE / floor: antracite 100x100-40"x40" NAT.RET. R11







SKYLINE / floor: fumo 320x160-126"x63" NAT.RET.





SKYLINE / floor: fumo 100x100-40"x40" NAT.RET.







SKYLINE / floor and wall: ghiaccio 100x100-40"x40" NAT.RET.





SKYLINE / floor: ghiaccio 360x120-126"x63" NAT.RET.  
SKYLINE / backsplash: ghiaccio 160x80-63"x31½" NAT.RET.







SKYLINE / floor: ghiaccio 320x160-126"x63" NAT.RET.  
SKYLINE / wall: antracite 320x160-126"x63" NAT.RET.





SKYLINE / wall: ghiaccio 320x160-126"x63" NAT.RET.





SKYLINE / floor: beige 100x100-40"x40" NAT.RET.  
SKYLINE / wall: beige 320x160-126"x63" NAT.RET.





SKYLINE / floor and wall: beige 240x120-96"x48" NAT.RET.  
SKYLINE / wall: fumo 240x120-96"x48" NAT.RET.







SKYLINE / floor and wall: beige 320x160-126"x63" NAT.RET.

# SKYLINE

## LASTRE IN GRES PORCELLANATO PRESSATE A SECCO

Dry-pressed porcelain stoneware slabs. Dalles en grès cérame pressées à sec. Trockengepresste Platten aus Feinsteinzeug. Planchas en gres porcelánico prensadas en seco. Керамогранитные плиты сухого прессования. 干压陶瓷砖

UNI EN 14411-ISO 13006 appendice G gruppo B1a - UGL

---

## ANTRACITE



Grafiche Diverse per formato.

Different patterns (based on size). Différents graphismes par format. Je nach Format verschiedene Grafiken.

Gráficas diferentes según formato. Кол. вариантов графики для каждого формата. 不同格式的图形

7

324x163

28

160x80

7

320x160

56

80x80

14

160x160

14

100x100

11

240x120

23

120x60

22

120x120

56

60x60

# ANTRACITE

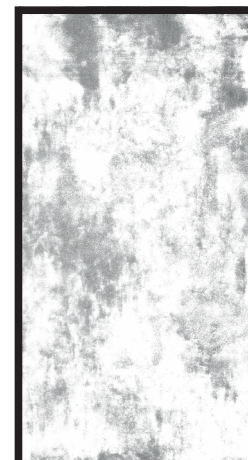

## SKYLINE

### SHADE SPECTRUM

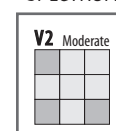

SOLO SUPERFICIE NATURALE  
Only Natural Surface

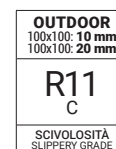

\* Disponibile con ordine minimo di 1.200 m<sup>2</sup>.  
Available with minimum order of 1.200 m<sup>2</sup>.  
Quantité minimale par commande 1200 m<sup>2</sup>.  
Erhältlich bei einer Mindestbestellmenge von 1.200 m<sup>2</sup>.  
Disponibile bajo pedido mínimo de 1.200 m<sup>2</sup>.  
При минимальном заказе от 1200 м<sup>2</sup>.  
最少订购1,200平方米

100% DESIGN  
AND PRODUCTION  
OF ITALY



# SKYLINE

## LASTRE IN GRES PORCELLANATO PRESSATE A SECCO

Dry-pressed porcelain stoneware slabs. Dalles en grès cérame pressées à sec. Trockengepresste Platten aus Feinsteinzeug. Planchas en gres porcelánico prensadas en seco. Керамогранитные плиты сухого прессования. 干压陶瓷砖

UNI EN 14411-ISO 13006 appendice G gruppo BIa - UGL

---

## FUMO



### Grafiche Diverse per formato.

Different patterns (based on size). Différents graphismes par format. Je nach Format verschiedene Grafiken.

Gráficas diferentes según formato. Кол. вариантов графики для каждого формата. 不同格式的图形

7

324x163

28

160x80

7

320x160

56

80x80

14

160x160

14

100x100

11

240x120

23

120x60

22

120x120

56

60x60

FUMO



SKYLINE

SHADE  
SPECTRUM

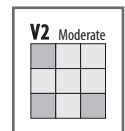

SOLO SUPERFICIE NATURALE  
Only Natural Surface

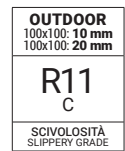

\* Disponibile con ordine minimo di 1.200 m<sup>2</sup>.  
Available with minimum order of 1.200 m<sup>2</sup>.  
Quantité minimale par commande 1200 m<sup>2</sup>.  
Erhältlich bei einer Mindestbestellmenge von 1.200 m<sup>2</sup>.  
Disponibile bajo pedido mínimo de 1.200 m<sup>2</sup>.  
При минимальном заказе от 1200 м<sup>2</sup>.  
最少订购1,200平方米

100% DESIGN  
AND PRODUCTION  
OF ITALY



# SKYLINE

## LASTRE IN GRES PORCELLANATO PRESSATE A SECCO

Dry-pressed porcelain stoneware slabs. Dalles en grès cérame pressées à sec. Trockengepresste Platten aus Feinsteinzeug. Planchas en gres porcelánico prensadas en seco. Керамогранитные плиты сухого прессования. 干压陶瓷砖

UNI EN 14411-ISO 13006 appendice G gruppo B1a - UGL

---

## GHIACCIO

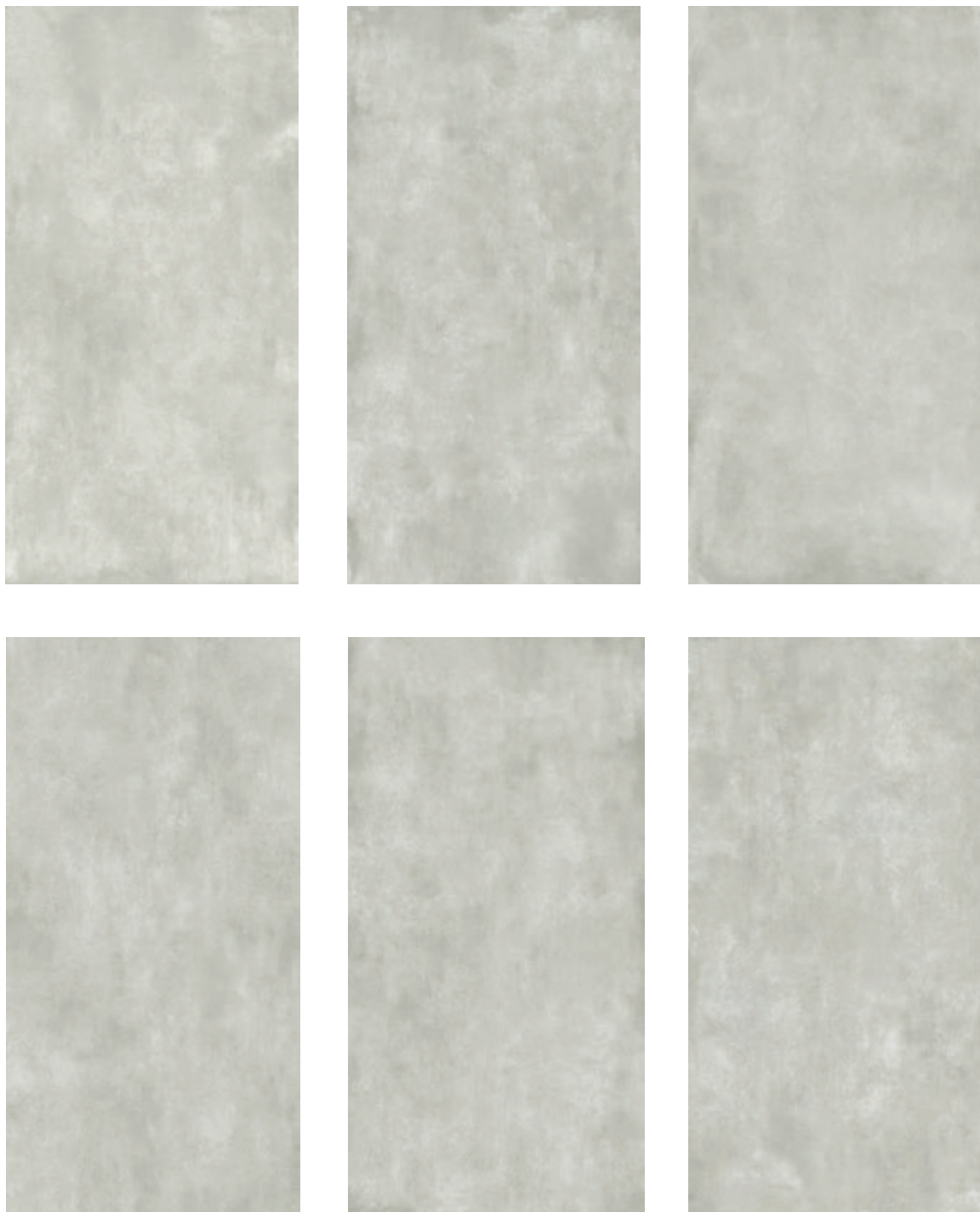

### Grafiche Diverse per formato.

Different patterns (based on size). Différents graphismes par format. Je nach Format verschiedene Grafiken.

Gráficas diferentes según formato. Кол. вариантов графики для каждого формата. 不同格式的图形

---

7

324x163

---

28

160x80

---

7

320x160

---

56

80x80

---

14

160x160

---

14

100x100

---

11

240x120

---

23

120x60

---

22

120x120

---

56

60x60

# GHIACCIO

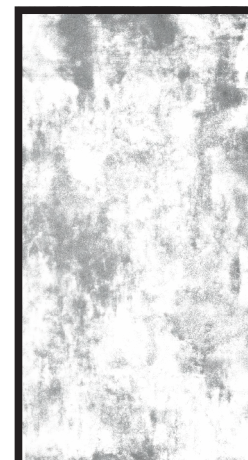

## SKYLINE

### SHADE SPECTRUM

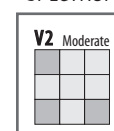

SOLO SUPERFICIE NATURALE  
Only Natural Surface

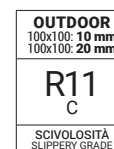

\* Disponibile con ordine minimo di 1.200 m<sup>2</sup>.  
Available with minimum order of 1.200 m<sup>2</sup>.  
Quantité minimale par commande 1200 m<sup>2</sup>.  
Erhältlich bei einer Mindestbestellmenge von 1.200 m<sup>2</sup>.  
Disponibile bajo pedido mínimo de 1.200 m<sup>2</sup>.  
При минимальном заказе от 1200 м<sup>2</sup>.  
最少订购1,200平方米

100% DESIGN  
AND PRODUCTION  
OF ITALY





# SKYLINE

## LASTRE IN GRES PORCELLANATO PRESSATE A SECCO

Dry-pressed porcelain stoneware slabs. Dalles en grès cérame pressées à sec. Trockengepresste Platten aus Feinsteinzeug. Planchas en gres porcelánico prensadas en seco. Керамогранитные плиты сухого прессования. 干压陶瓷砖

UNI EN 14411-ISO 13006 appendice C gruppo B1a - UGL

---

## BEIGE

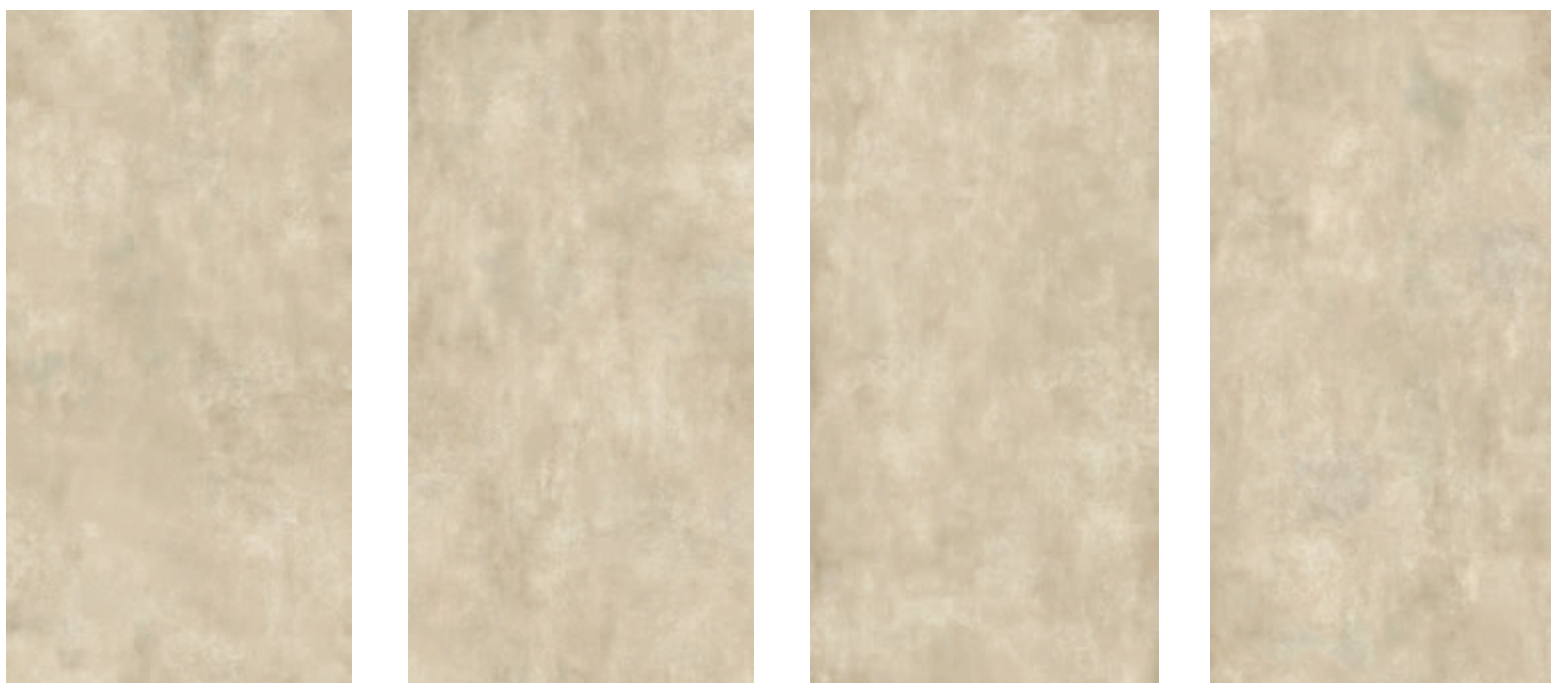

### Grafiche Diverse per formato.

Different patterns (based on size). Différents graphismes par format. Je nach Format verschiedene Grafiken.

Gráficas diferentes según formato. Кол. вариантов графики для каждого формата. 不同格式的图形

7

324x163

28

160x80

7

320x160

56

80x80

14

160x160

14

100x100

11

240x120

23

120x60

22

120x120

56

60x60

BEIGE

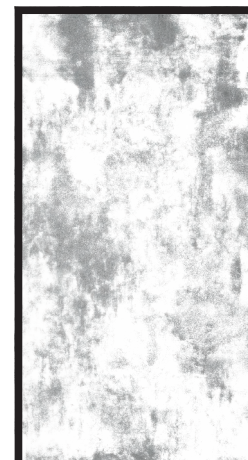

SKYLINE

SHADE  
SPECTRUM

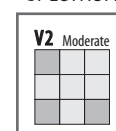

ANSI A  
137.1: 2012

WET DYNAMIC  
COEFFICIENT  
OF FRICTION

DCOF  $\geq$  0,42

SOLO SUPERFICIE NATURALE  
Only Natural Surface

OUTDOOR  
100x100: 10 mm  
100x100: 20 mm

R11  
C

SCIVOLOSITÀ  
SLIPPERY GRADE



\* Disponibile con ordine minimo di 1.200 m<sup>2</sup>.  
Available with minimum order of 1.200 m<sup>2</sup>.  
Quantité minimale par commande 1200 m<sup>2</sup>.  
Erhältlich bei einer Mindestbestellmenge von 1.200 m<sup>2</sup>.  
Disponibile bajo pedido mínimo de 1.200 m<sup>2</sup>.  
При минимальном заказе от 1200 м<sup>2</sup>.  
最少订购1,200平方米

100% DESIGN  
AND PRODUCTION  
OF ITALY



# SKYLINE

## LASTRE IN GRES PORCELLANATO PRESSATE A SECCO









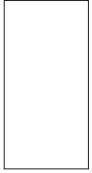

Dry-pressed porcelain stoneware slabs. Dalles en grès cérame pressées à sec. Trockengepresste Platten aus Feinsteinzeug. Planchas en gres porcelánico prensadas en seco. Керамогранитные плиты сухого прессования. 干压陶瓷砖

## UNI EN 14411-ISO 13006 appendice G gruppo Bla - UGL

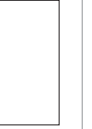
Spessore. Thickness. Epaisseur. Stärke. Espesor. Толщина. 厚度 **6 mm - 10 mm - 10 mm R11 - 12 mm\* - 20 mm R11**

Grande varietà nelle grafiche per un pavimento o rivestimento sempre vario a effetto "naturale" - The collection is available in a wide variety of graphics for varied floor or wall solutions with a "natural" effect. Grande variété des graphiques pour un carrelage de sol ou un revêtement mural toujours différent et un effet "naturel". - Große Vielfalt der Graphiken für einen ständig unterschiedlichen Boden- oder Wandbelag mit "natürlichem" Effekt. - Gran variedad en las gráficas para un pavimento o revestimiento siempre diferente de efecto "natural". - Предлагается большое разнообразие рисунков для укладки всегда меняющегося пола или облицовки с натуральным эффе́ктом. - 多样的图案让地板和涂层具有不同的“天然”色彩。

**Mxxx:** Codice prezzo al mq. Sqm price code. Code prix au mq. Kode Preis pro Qm. Código de precio por metro cuadrado. цена за м<sup>2</sup>. 每平方米价格代码。

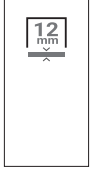
		MODULAR SYSTEM				MODULAR SYSTEM			MODULAR SYSTEM			
												
		<b>320x160</b> 126"x63" <b>6 mm</b>	<b>160x160</b> 63"x63" <b>6 mm</b>	<b>160x80</b> 63"x31 1/2" <b>6 mm</b>	<b>80x80</b> 31 1/2"x31 1/2" <b>6 mm</b>	<b>240x120</b> 96"x48" <b>6 mm</b>	<b>120x120</b> 48"x48" <b>6 mm</b>	<b>120x60</b> 48"x24" <b>10 mm</b>	<b>60x60</b> 24"x24" <b>10 mm</b>	<b>100x100</b> 40"x40" <b>10 mm</b>	<b>100x100</b> 40"x40" <b>20 mm</b>	<b>324x163</b> 127"x64" <b>12 mm*</b>
Antracite	□ Nat. Ret.	082010 <b>M173</b>	082050 <b>M161</b>	082090 <b>M141</b>	082110 <b>M125</b>	082030 <b>M153</b>	082070 <b>M141</b>	082130 <b>M109</b>	082150 <b>M089</b>	082094 <b>M109</b>	-	-
	□ Nat. Ret. R11	-	-	-	-	-	-	-	-	082098 <b>M109</b>	082114 <b>M143</b>	-
	○ Lap. Ret.	-	-	-	-	-	-	082131 <b>M125</b>	082151 <b>M113</b>	-	-	-
	■ Nat.	-	-	-	-	-	-	-	-	-	-	082910 <b>M221</b>
Fumo	□ Nat. Ret.	082007 <b>M173</b>	082047 <b>M161</b>	082087 <b>M141</b>	082107 <b>M125</b>	082027 <b>M153</b>	082067 <b>M141</b>	082127 <b>M109</b>	082147 <b>M089</b>	082091 <b>M109</b>	-	-
	□ Nat. Ret. R11	-	-	-	-	-	-	-	-	082095 <b>M109</b>	082111 <b>M143</b>	-
	○ Lap. Ret.	-	-	-	-	-	-	082128 <b>M125</b>	082148 <b>M113</b>	-	-	-
	■ Nat.	-	-	-	-	-	-	-	-	-	-	082907 <b>M221</b>











Il formato 324x163 in 12 mm è prodotto senza stuoia. La stuoia potrà essere aggiunta solo su specifica richiesta. Lo spessore delle lastre stuoiate è di 12,7 mm.  
The 324x163 size 12 mm thickness is produced without the fiber glass mesh. The fiber glass mesh will be supplied only on demand. The thickness of the mesh-mounted is 12,7 mm

\* **Disponibile con ordine minimo di 1.200 m<sup>2</sup>.** Available with minimum order of 1,200 m<sup>2</sup>. Quantité minimale par commande 1200 m<sup>2</sup>. Erhältlich bei einer Mindestbestellmenge von 1.200 m<sup>2</sup>. Disponible bajo pedido mínimo de 1.200 m<sup>2</sup>. При минимальном заказе от 1200 м<sup>2</sup>. 最少订购1,200平方米

□ **Naturale e rettificato.** Natural and rectified. Naturel et rectifié. Natur Oberfläche und kalibriert. Natural y rectificado. Натуральный ректифицированный. 天然和抛光。  
○ **Lappato e rettificato.** Lappato and rectified. Lappato et rectifié. Lappato und kalibriert. Lappato y rectificado. Лаппатированный ректифицированный. 亚光和抛光。

■ **Naturale.** Natural. Naturel. Natur natur. Natural. Натуральный. 天然。

La collezione Skyline appartiene alla categoria Contemporanei ed è consultabile anche sul General Catalogue 2020 di AVA - The Skyline collection, which comes under the Contemporary category, can also be viewed in the AVA General Catalogue 2020 G. La collection Skyline appartient à la catégorie Contemporanei et elle peut être consultée aussi dans le Catalogue Général 2020 d'AVA. Die Kollektion Skyline gehört zur Kategorie Modern und kann auch im AVA-Gesamtkatalog 2020 eingesehen werden. La colección Skyline pertenece a la categoría Contemporáneos y también puede ser consultada en el Catálogo General 2020 de AVA. Коллекция Skyline представлена в разделе "Contemporanei" и она приводится также в сводном каталоге General Catalogue 2020 AVA. Skyline系列属于当代品类, 也可以在AVA通用目录2020中查阅。

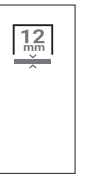
		MODULAR SYSTEM				MODULAR SYSTEM				MODULAR SYSTEM		
												
		<b>320x160</b> 126"x63" 6 mm	<b>160x160</b> 63"x63" 6 mm	<b>160x80</b> 63"x31 1/2" 6 mm	<b>80x80</b> 31 1/2"x31 1/2" 6 mm	<b>240x120</b> 96"x48" 6 mm	<b>120x120</b> 48"x48" 6 mm	<b>120x60</b> 48"x24" 10 mm	<b>60x60</b> 24"x24" 10 mm	<b>100x100</b> 40"x40" 10 mm	<b>100x100</b> 40"x40" 20 mm	<b>324x163</b> 127"x64" 12 mm*
Ghiaccio	□ Nat. Ret.	082001 M173	082041 M161	082081 M141	082101 M125	082021 M153	082061 M141	082121 M109	082141 M089	082093 M109	-	-
	□ Nat. Ret. R11	-	-	-	-	-	-	-	-	082097 M109	082113 M143	-
	○ Lap. Ret.	-	-	-	-	-	-	082122 M125	082142 M113	-	-	-
	■ Nat.	-	-	-	-	-	-	-	-	-	-	082901 M221
Beige	□ Nat. Ret.	082004 M173	082044 M161	082084 M141	082104 M125	082024 M153	082064 M141	082124 M109	082144 M089	082092 M109	-	-
	□ Nat. Ret. R11	-	-	-	-	-	-	-	-	082096 M109	082112 M143	-
	○ Lap. Ret.	-	-	-	-	-	-	082125 M125	082145 M113	-	-	-
	■ Nat.	-	-	-	-	-	-	-	-	-	-	082904 M221

Il formato 324x163 in 12 mm è prodotto senza stuoia. La stuoia potrà essere aggiunta solo su specifica richiesta. Lo spessore delle lastre stuoiato è di 12,7 mm.  
The 324x163 size 12 mm thickness is produced without the fiber glass mesh. The fiber glass mesh will be supplied only on demand. The thickness of the mesh-mounted is 12,7 mm

\* Disponibile con ordine minimo di 1.200 m<sup>2</sup>. Available with minimum order of 1,200 m<sup>2</sup>. Quantité minimale par commande 1200 m<sup>2</sup>. Erhältlich bei einer Mindestbestellmenge von 1.200 m<sup>2</sup>. Disponible bajo pedido mínimo de 1.200 m<sup>2</sup>. При минимальном заказе от 1200 м<sup>2</sup>. 最少订购1,200平方米

□ Naturale e rettificato. Natural and rectified. Naturel et rectifié. Natur Oberfläche und kalibriert. Natural y rectificado. Натуральный ректифицированный. 天然和抛光。  
○ Lappato e Rettificato. Lappato and rectified. Lappato et rectifié. Lappato und kalibriert. Lappato y rectificado. Лаппатированный ректифицированный. 亚光和抛光。

■ Naturale. Natural. Naturel. Natur natur. Natural. Натуральный. 天然。

# \*\* PEZZI SPECIALI

Trims . Pièces spéciales . Formstücke . Piezas especiales . Специальные элементы . 特别部件

**Pxxx:** Codice prezzo al pezzo. Code price per piece. Code prix à la pièce. Kode Preis pro Stück. Código de precio por unidades. цена за шт. 每片价格代码.

## COSTA RETTA: Straight nose:

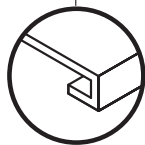
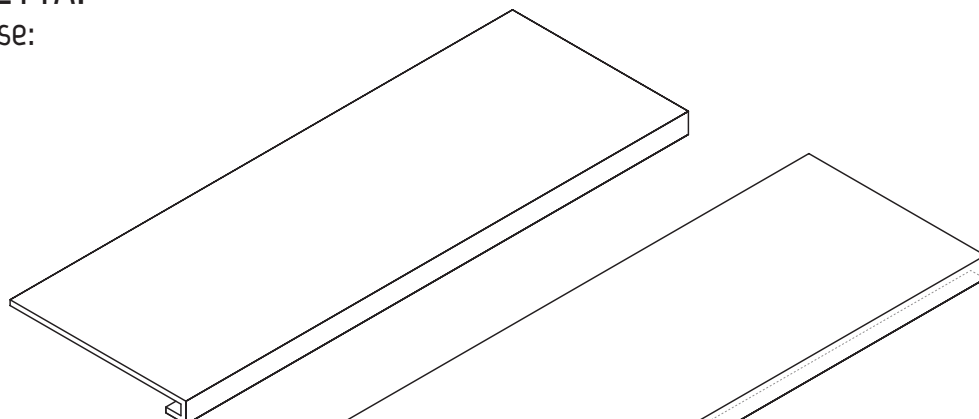

Gradino  
costa retta  
Straight  
nosed stair

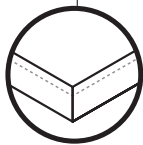

Gradino  
costa retta angolo  
Straight nosed  
corner step

Gradino Costa Retta  
**160x33x3,2h** - 63"x13"x1 1/4"h  
□ Nat. Ret. **6 mm**

Gradino Costa Retta  
**120x33x3,2h** - 48"x13"x1 1/4"h  
□ Nat. Ret. **6 mm**

Gradino Costa Retta  
**80x33x3,2h** - 31 1/2"x13"x1 1/4"h  
□ Nat. Ret. **6 mm**

Gradino Costa Retta  
**120x33x3,2h** - 48"x13"x1 1/4"h  
□ Nat. Ret. **10 mm**  
○ Lap. Ret. **10 mm**

Gradino Costa Retta Dx/Sx  
**160x33x3,2h** - 63"x13"x1 1/4"h  
□ Nat. Ret. **6 mm**

Gradino Costa Retta Dx/Sx  
**120x33x3,2h** - 48"x13"x1 1/4"h  
□ Nat. Ret. **6 mm**

Gradino Costa Retta Dx/Sx  
**80x33x3,2h** - 31 1/2"x13"x1 1/4"h  
□ Nat. Ret. **6 mm**

Gradino Costa Retta Dx/Sx  
**120x33x3,2h** - 48"x13"x1 1/4"h  
□ Nat. Ret. **10 mm**  
○ Lap. Ret. **10 mm**

## BORDO DRITTO: Straight edge:

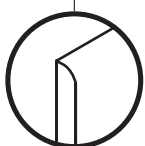
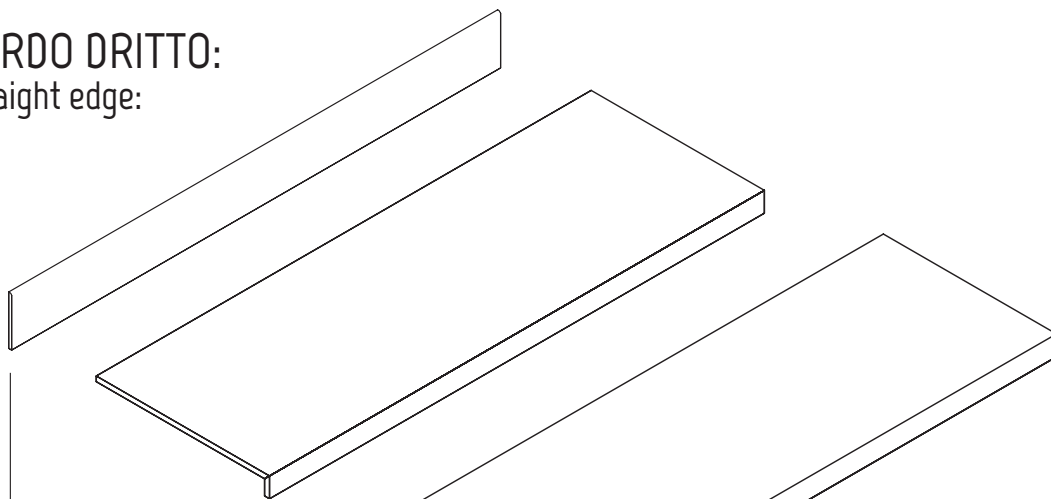

Battiscopa  
Skirting

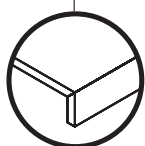

Gradino  
bordo dritto  
Straight-edge  
step

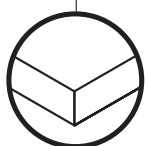

Gradino  
bordo dritto angolo  
Straight-edge  
corner step

Gradino Bordo Dritto  
**160x30x4h** - 63"x12"x1 1/2"h  
□ Nat. Ret. **6 mm**

Gradino Bordo Dritto  
**120x30x4h** - 48"x12"x1 1/2"h  
□ Nat. Ret. **6 mm**

Gradino Bordo Dritto  
**80x30x4h** - 31 1/2"x12"x1 1/2"h  
□ Nat. Ret. **6 mm**

Gradino Bordo Dritto  
**120x30x4h** - 48"x12"x1 1/2"h  
□ Nat. Ret. **10 mm**  
○ Lap. Ret. **10 mm**

Gradino Bordo Dritto Dx/Sx  
**160x30x4h** - 63"x12"x1 1/2"h  
□ Nat. Ret. **6 mm**

Gradino Bordo Dritto Dx/Sx  
**120x30x4h** - 48"x12"x1 1/2"h  
□ Nat. Ret. **6 mm**

Gradino Bordo Dritto Dx/Sx  
**80x30x4h** - 31 1/2"x12"x1 1/2"h  
□ Nat. Ret. **6 mm**

Gradino Bordo Dritto Dx/Sx  
**120x30x4h** - 48"x12"x1 1/2"h  
□ Nat. Ret. **10 mm**  
○ Lap. Ret. **10 mm**

		Battiscopa 80x8 31 1/2"x3" 6 mm	Battiscopa 120x6,5 48"x2 1/2" 10 mm
Antracite	<input type="checkbox"/> Nat. Ret.	082204 <b>P025</b>	082212 <b>P029</b>
	<input type="radio"/> Lap. Ret.	-	082436 <b>P033</b>
Fumo	<input type="checkbox"/> Nat. Ret.	082203 <b>P025</b>	082211 <b>P029</b>
	<input type="radio"/> Lap. Ret.	-	082435 <b>P033</b>
Ghiaccio	<input type="checkbox"/> Nat. Ret.	082201 <b>P025</b>	082209 <b>P029</b>
	<input type="radio"/> Lap. Ret.	-	082433 <b>P033</b>
Beige	<input type="checkbox"/> Nat. Ret.	082202 <b>P025</b>	082210 <b>P029</b>
	<input type="radio"/> Lap. Ret.	-	082434 <b>P033</b>

		Gradino Costa Retta 160x33x3,2h 63"x13"x1 1/4"h 6 mm	Gradino Costa Retta DXSX 160x33x3,2h 63"x13"x1 1/4"h 6 mm	Gradino Costa Retta 120x33x3,2h 48"x13"x1 1/4"h 6 mm	Gradino Costa Retta DXSX 120x33x3,2h 48"x13"x1 1/4"h 6 mm
Antracite	<input type="checkbox"/> Nat. Ret.	082244 <b>P303</b>	082276 DX 082308 SX <b>P319</b>	082252 <b>P243</b>	082284 DX 082316 SX <b>P273</b>
	<input type="radio"/> Lap. Ret.	-	-	-	-
Fumo	<input type="checkbox"/> Nat. Ret.	082207 <b>P303</b>	082275 DX 082307 SX <b>P319</b>	082251 <b>P243</b>	082283 DX 082315 SX <b>P273</b>
	<input type="radio"/> Lap. Ret.	-	-	-	-
Ghiaccio	<input type="checkbox"/> Nat. Ret.	082205 <b>P303</b>	082273 DX 082305 SX <b>P319</b>	082249 <b>P243</b>	082281 DX 082313 SX <b>P273</b>
	<input type="radio"/> Lap. Ret.	-	-	-	-
Beige	<input type="checkbox"/> Nat. Ret.	082206 <b>P303</b>	082274 DX 082306 SX <b>P319</b>	082250 <b>P243</b>	082282 DX 082314 SX <b>P273</b>
	<input type="radio"/> Lap. Ret.	-	-	-	-

**\*\* A disposizione solo su richiesta. Tempi di consegna: 30gg.** Available upon request only. Delivery terms: 30 days. Disponible seulement sur requête. Délais de livraison: 30 jours. Verfügbar auf Anfrage. Lieferzeit: 30 Tage. Disponible sólo bajo pedido. Plazo de entrega: 30 días. Изготавливается только по специальной заявке. Срок поставки: 30 дней. 仅依订购。交货时间: 30日。

**Naturale e rettificato.** Natural and rectified. Naturel et rectifié. Natur Oberfläche und kalibriert. Natural y rectificado. Натуральный ректифицированный. 天然和抛光。

**Lappato e Rettificato.** Lappato and rectified. Lappato et rectifié. Lappato und kalibriert. Lappato y rectificado. Лаппатированный ректифицированный. 亚光和抛光。



		Gradino Costa Retta 80x33x3,2h 31½"x13"x1¼"h 6 mm	Gradino Costa Retta DXSX 80x33x3,2h 31½"x13"x1¼"h 6 mm	Gradino Costa Retta 120x33x3,2h 48"x13"x1¼"h 10 mm	Gradino Costa Retta DXSX 120x33x3,2h 48"x13"x1¼"h 10 mm
Antracite	<input type="checkbox"/> Nat. Ret.	082260 <b>P167</b>	082292 DX 082324 SX <b>P203</b>	082268 <b>P207</b>	082300 DX 082332 SX <b>P231</b>
	<input type="radio"/> Lap. Ret.	-	-	082452 <b>P215</b>	082460 DX 082468 SX <b>P243</b>
Fumo	<input type="checkbox"/> Nat. Ret.	082259 <b>P167</b>	082291 DX 082323 SX <b>P203</b>	082267 <b>P207</b>	082299 DX 082331 SX <b>P231</b>
	<input type="radio"/> Lap. Ret.	-	-	082451 <b>P215</b>	082459 DX 083467 SX <b>P243</b>
Ghiaccio	<input type="checkbox"/> Nat. Ret.	082257 <b>P167</b>	082289 DX 082321 SX <b>P203</b>	082265 <b>P207</b>	082297 DX 082329 SX <b>P231</b>
	<input type="radio"/> Lap. Ret.	-	-	082449 <b>P215</b>	082457 DX 082465 SX <b>P243</b>
Beige	<input type="checkbox"/> Nat. Ret.	082258 <b>P167</b>	082290 DX 082322 SX <b>P203</b>	082266 <b>P207</b>	082298 DX 082330 SX <b>P231</b>
	<input type="radio"/> Lap. Ret.	-	-	082450 <b>P215</b>	082458 DX 082466 SX <b>P243</b>



		Gradino Bordo Dritto 160x30x4h 63"x12"x1¼"h 6 mm	Gradino Bordo Dritto DXSX 160x30x4h 63"x12"x1¼"h 6 mm	Gradino Costa Retta 120x30x4h 48"x12"x1¼"h 6 mm	Gradino Bordo Dritto DXSX 120x30x4h 48"x12"x1¼"h 6 mm
Antracite	<input type="checkbox"/> Nat. Ret.	082340 <b>P245</b>	082372 DX 082404 SX <b>P287</b>	082348 <b>P193</b>	082380 DX 082412 SX <b>P245</b>
	<input type="radio"/> Lap. Ret.	-	-	-	-
Fumo	<input type="checkbox"/> Nat. Ret.	082339 <b>P245</b>	082371 DX 082403 SX <b>P287</b>	082347 <b>P193</b>	082379 DX 082411 SX <b>P245</b>
	<input type="radio"/> Lap. Ret.	-	-	-	-
Ghiaccio	<input type="checkbox"/> Nat. Ret.	082337 <b>P245</b>	082369 DX 082401 SX <b>P287</b>	082345 <b>P193</b>	082377 DX 092409 SX <b>P245</b>
	<input type="radio"/> Lap. Ret.	-	-	-	-
Beige	<input type="checkbox"/> Nat. Ret.	082338 <b>P245</b>	082370 DX 082402 SX <b>P287</b>	082346 <b>P193</b>	082378 DX 082410 SX <b>P245</b>
	<input type="radio"/> Lap. Ret.	-	-	-	-



		Gradino Bordo Dritto 80x30x4h 31½"x12"x1¼"h 6 mm	Gradino Bordo Dritto DXSX 80x30x4h 31½"x12"x1¼"h 6 mm	Gradino Bordo Dritto 120x30x4h 48"x12"x1¼"h 10 mm	Gradino Bordo Dritto DXSX 120x30x4h 48"x12"x1¼"h 10 mm
Antracite	<input type="checkbox"/> Nat. Ret.	082356 <b>P135</b>	082388 DX 082420 SX <b>P183</b>	082364 <b>P173</b>	082396 DX 082428 SX <b>P201</b>
	<input type="radio"/> Lap. Ret.	-	-	082476 <b>P179</b>	082484 DX 082492 SX <b>P201</b>
Fumo	<input type="checkbox"/> Nat. Ret.	082355 <b>P135</b>	082387 DX 082419 SX <b>P183</b>	082363 <b>P173</b>	082395 DX 082427 SX <b>P201</b>
	<input type="radio"/> Lap. Ret.	-	-	082475 <b>P179</b>	082483 DX 082491 SX <b>P201</b>
Ghiaccio	<input type="checkbox"/> Nat. Ret.	082353 <b>P135</b>	082385 DX 082417 SX <b>P183</b>	082361 <b>P173</b>	082393 DX 082425 SX <b>P201</b>
	<input type="radio"/> Lap. Ret.	-	-	082473 <b>P179</b>	082481 DX 082489 SX <b>P201</b>
Beige	<input type="checkbox"/> Nat. Ret.	082354 <b>P135</b>	082386 DX 082418 SX <b>P183</b>	082362 <b>P173</b>	082394 DX 082426 SX <b>P201</b>
	<input type="radio"/> Lap. Ret.	-	-	082474 <b>P179</b>	082482 DX 082490 SX <b>P201</b>

## PEZZI SPECIALI SKYLINE 100x100

Trims 100x100 . Pièces spéciales 100x100 . Formstücke 100x100 . Piezas especiales 100x100 . Специальные элементы 100x100 . 特别部件 100x100.

		Battiscopa 100x7 40"x2¾"h 10 mm	Gradino Costa Retta** 100x33x3,2h 40"x13"x1¼"h 10 mm	Gradino Costa Retta Ang. DXSX** 100x33x3,2h 40"x13"x1¼"h 10 mm
Antracite	<input type="checkbox"/> Nat. Ret.	082120 <b>P029</b>	082248 <b>P207</b>	082280 DX** 082312 SX** <b>P219</b>
	<input type="checkbox"/> Nat. Ret. R11	-	082256 <b>P207</b>	082288 DX** 082320 SX** <b>P219</b>
Fumo	<input type="checkbox"/> Nat. Ret.	082117 <b>P029</b>	082245 <b>P207</b>	082277 DX** 082309 SX** <b>P219</b>
	<input type="checkbox"/> Nat. Ret. R11	-	082253 <b>P207</b>	082285 DX** 082317 SX** <b>P219</b>
Ghiaccio	<input type="checkbox"/> Nat. Ret.	082119 <b>P029</b>	082247 <b>P207</b>	082279 DX** 082311 SX** <b>P219</b>
	<input type="checkbox"/> Nat. Ret. R11	-	082255 <b>P207</b>	082287 DX** 082319 SX** <b>P219</b>
Beige	<input type="checkbox"/> Nat. Ret.	082118 <b>P029</b>	082246 <b>P207</b>	082278 DX** 082310 SX** <b>P219</b>
	<input type="checkbox"/> Nat. Ret. R11	-	082254 <b>P207</b>	082286 DX** 082318 SX** <b>P219</b>

\*\* A disposizione solo su richiesta. Tempi di consegna: 30gg. Available upon request only. Delivery terms: 30 days. Disponible seulement sur requête. Délais de livraison: 30 jours. Verfügbar auf Anfrage. Lieferzeit: 30 Tage. Disponible sólo bajo pedido. Plazo de entrega: 30 días. Изготавливается только по специальной заявке. Срок поставки: 30 дней. 仅依订购。交货时间: 30日。

Naturale e rettificato. Natural and rectified. Naturel et rectifié. Natur Oberfläche und kalibriert. Natural y rectificado. Натуральный ректифицированный. 天然和抛光。  
 Lappato e Rettificato. Lappato and rectified. Lappato et rectifié. Lappato und kalibriert. Lappato y rectificado. Лаппатированный ректифицированный. 亚光和抛光。



# DECORI

Decors. Décors. Dekore. Decoraciones. Декоры. 飾

**Mxxx:** Codice prezzo al mq. Sqm price code. Code prix au mq. Kode Preis pro Qm. Código de precio por metro cuadrado. цена за м². 每平方米价格代码。

**Pxxx:** Codice prezzo al pezzo. Code price per piece. Code prix à la pièce. Kode Preis pro Stück. Código de precio por unidades. цена за шт. 每件价格代码。

## MOSAICO

30x30cm. 12"x12"  
thickness 6mm

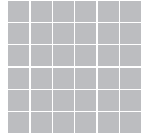

□ Nat. Ret. **M193**

082189 - Mosaico Antracite

082185 - Mosaico Fumo

082181 - Mosaico Ghiaccio

082183 - Mosaico Beige

Decori disponibili su tutti i colori in gamma.

Decors available for all the colors of this range.

Décors disponibles dans toutes les couleurs de la gamme.

Dekore in allen Farben der Kollektion verfügbar.

Decorados disponibles en todos los colores.

Декоры существуют во всех цветах коллекции.

裝飾可以运用所有的颜色

□ **Naturale e rettificato.** Natural and rectified. Naturel et rectifié. Natur Oberfläche und kalibriert. Natural y rectificado. Натуральный ректифицированный. 天然和拋光。

## 20MM SKYLINE 100x100

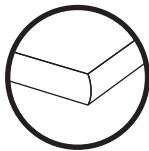

Costa Toro  
Bullnose  
edge

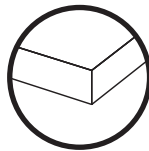

Costa Retta  
Straight  
edge

**Per il gradino non si garantisce la stessa tonalità del fondo.**

We cannot guarantee that the shade of the stair tile will be the same as the background tile. Pour la marche, nous ne garantissons pas la même tonalité du fond. - Für die Stufe wird nicht der gleiche Farbton der Grundfliese garantiert. Para el peldaño no se garantiza el mismo tono del fondo. Для ступени не гарантирована одинаковость тона с фоном. 对于台阶不保证底色一致

**Tra i fondi di spessore 10 e 20 mm non si garantisce l'abbinabilità.**

We cannot guarantee tonal matches between the same background tiles with different thickness (10 or 20 mm). Les assortiments des tons ne sont pas garantis pour les fonds d'une épaisseur de 10 et 20 mm. - Bei Bodenfliesen mit einer Stärke von 10 und 20 mm wird keine Einheitlichkeit der Farbtöne garantiert. Para los fondos de espesor 10 y 20 mm no se garantiza la combinabilidad de tonalidades. - Для фоновой плитки толщиной 10 и 20 мм не гарантирована цветовая сочетаемость.

## GRADONI - Swimmingpool & Outdoor - R11C

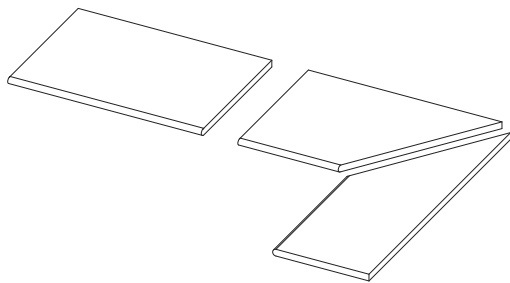

### Gradone bordo 50

Large step 50  
Nez de marche avec bord 50  
Stufenplatten 50

100x50 . 40"x20"

□ Costa Retta □ Nat. Ret. 20mm R11C  
**P185**

082604 - Antracite  
082601 - Fumo  
082603 - Ghiaccio  
082602 - Beige

□ Costa Toro □ Nat. Ret. 20mm R11C  
**P203**

082616 - Antracite  
082613 - Fumo  
082615 - Ghiaccio  
082614 - Beige

### Gradone bordo 50 Dx/Sx

L-shaped border "A"  
Bord en L « A »  
Rand L "A"-förmig

100x50 . 40"x20"

□ Costa Retta □ Nat. Ret. 20mm R11C  
**P203**

082608 DX . 082612 SX - Antracite  
082605 DX . 082609 SX - Fumo  
082607 DX . 082611 SX - Ghiaccio  
082606 DX . 082610 SX - Beige

□ Costa Toro □ Nat. Ret. 20mm R11C  
**P221**

082620 DX . 082624 SX - Antracite  
082617 DX . 082621 SX - Fumo  
082619 DX . 082623 SX - Ghiaccio  
082618 DX . 082622 SX - Beige

## GRADONE BORDO - Swimmingpool & Outdoor - R11C

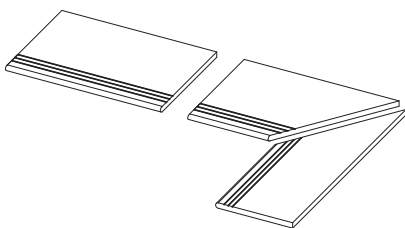

### Gradone bordo 50 grip

Large step with anti-slip border  
Nez de marche avec antidérapant  
Stufenplatten gerillt

100x50 . 40"x20"

□ Costa Retta □ Nat. Ret. 20mm R11C  
**P207**

082688 - Antracite  
082685 - Fumo  
082687 - Ghiaccio  
082686 - Beige

□ Costa Toro □ Nat. Ret. 20mm R11C  
**P227**

082700 - Antracite  
082697 - Fumo  
082699 - Ghiaccio  
082698 - Beige

### Gradone bordo 50 grip Dx/Sx

Large step with anti-slip border  
Nez de marche avec antidérapant  
Stufenplatten gerillt

100x50 . 40"x20"

□ Costa Retta □ Nat. Ret. 20mm R11C  
**P225**

082692 DX . 082696 SX - Antracite  
082689 DX . 082693 SX - Fumo  
082691 DX . 082695 SX - Ghiaccio  
082690 DX . 082694 SX - Beige

□ Costa Toro □ Nat. Ret. 20mm R11C  
**P245**

082704 DX . 082708 SX - Antracite  
082701 DX . 082705 SX - Fumo  
082703 DX . 082707 SX - Ghiaccio  
082702 DX . 082706 SX - Beige

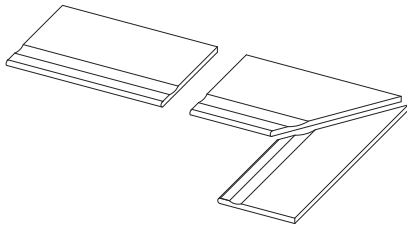

**Gradone bordo 50 svasato**  
Large step with rounded border  
Nez de marche bord boudin  
Stufenplatten gerippt

**100x50 . 40"x20"**

**Costa Retta** □ Nat. Ret. 20mm R11C  
**P295**  
082712 - Antracite  
082709 - Fumo  
082711 - Ghiaccio  
082710 - Beige

**Costa Toro** □ Nat. Ret. 20mm R11C  
**P311**  
082724 - Antracite  
082721 - Fumo  
082723 - Ghiaccio  
082722 - Beige

**Gradone bordo 50 svasato Dx/Sx**  
Large step with rounded border  
Nez de marche bord boudin  
Stufenplatten gerippt

**100x50 . 40"x20"**

**Costa Retta** □ Nat. Ret. 20mm R11C  
**P305**  
082716 DX . 082720 SX - Antracite  
082713 DX . 082717 SX - Fumo  
082715 DX . 082719 SX - Ghiaccio  
082714 DX . 082718 SX - Beige

**Costa Toro** □ Nat. Ret. 20mm R11C  
**P321**  
082728 DX . 082732 SX - Antracite  
082725 DX . 082729 SX - Fumo  
082727 DX . 082731 SX - Ghiaccio  
082726 DX . 082730 SX - Beige

**GRIGLIE - Swimmingpool & Outdoor - R11C**

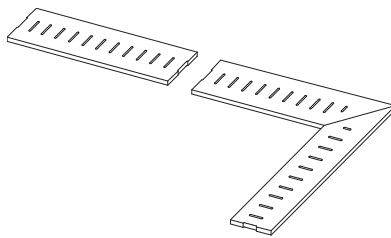

**Griglia 20**  
Drainage grid 30  
Drainage grille 30  
Rinnenabdeckung 30

**20x100 . 8"x40"**

□ Nat. Ret. 20mm R11C  
**P291**  
082664 - Antracite  
082661 - Fumo  
082663 - Ghiaccio  
082662 - Beige

**Griglia 20 Dx/Sx**  
Drainage grid 30  
Drainage grille 30  
Rinnenabdeckung 30

**20x100 . 8"x40"**

□ Nat. Ret. 20mm R11C  
**P291**  
082668 DX . 082672 SX - Antracite  
082665 DX . 082669 SX - Fumo  
082667 DX . 082671 SX - Ghiaccio  
082666 DX . 082670 SX - Beige

**BORDI - Outdoor - R11C**

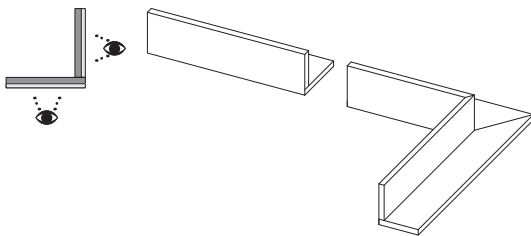

**Bordo L "A"**  
L-shaped border "A"  
Bord en L « A »  
Rand L "A"-Förmig

**10x100x10h . 4"x40"x4"h**

□ Nat. Ret. 20mm R11C  
**P193**  
082628 - Antracite  
082625 - Fumo  
082627 - Ghiaccio  
082626 - Beige

**Bordo L "A" Dx/Sx**  
L-shaped border "A"  
Bord en L « A »  
Rand L "A"-Förmig

**10x100x10h . 4"x40"x4"h**

□ Nat. Ret. 20mm R11C  
**P223**  
082632 DX . 082636 SX - Antracite  
082629 DX . 082633 SX - Fumo  
082631 DX . 082635 SX - Ghiaccio  
082630 DX . 082634 SX - Beige

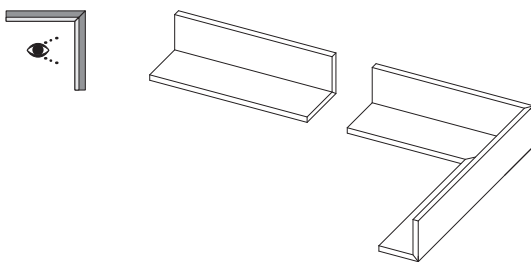

**Bordo L "B"**  
L-shaped border "B"  
Bord en L « B »  
Rand L "B"-Förmig

**10x100x10h . 4"x40"x4"h**

□ Nat. Ret. 20mm R11C  
**P257**  
082640 - Antracite  
082637 - Fumo  
082639 - Ghiaccio  
082638 - Beige

**Bordo L "B" Dx/Sx**  
L-shaped border "B"  
Bord en L « B »  
Rand L "B"-Förmig

**10x100x10h . 4"x40"x4"h**

□ Nat. Ret. 20mm R11C  
**P277**  
082644 DX . 082648 SX - Antracite  
082641 DX . 082645 SX - Fumo  
082643 DX . 082647 SX - Ghiaccio  
082642 DX . 082646 SX - Beige

□ Naturale e rettificato. Natural and rectified. Naturel et rectifié. Natur Oberfläche und kalibriert. Natural y rectificado. Натуральный ректифицированный. 天然和拋光。

**ATTENZIONE: Per particolari installazioni potrebbero essere necessari articoli ed accessori specifici non presenti in questo catalogo. Per queste esigenze pregò riferirsi direttamente al referente commerciale La Fabbrica.** - N.B. Particular items and accessories not listed in this catalogue may be required for certain laying methods. For these needs, please contact the La Fabbrica sales sales directly. ATTENTION : Pour les installations particulières, certains articles et accessoires particuliers qui ne sont pas indiqués dans ce catalogue pourraient être nécessaires. Dans ces cas-là, nous vous prions de vous référer directement à la référence commerciale La Fabbrica. - ACHTUNG: Für besondere Installationen können besondere Artikel oder Sonderzubehör notwendig sein, die nicht im vorliegenden Katalog aufgeführt sind. Wenden Sie sich bitte in diesen Fällen direkt an den Vertrieb von La Fabbrica. - ATENCION: para instalaciones particulares podrían requerirse artículos y accesorios específicos que no están presentes en este catálogo. Para tales casos rogamos contactar directamente al representante comercial de La Fabbrica. - ВНИМАНИЕ: Для особых применений могут быть необходимы специальные артикулы и аксессуары, не представленные в данном каталоге. По поводу этих вопросов просим вас обращаться непосредственно к менеджеру коммерческого отдела компании La Fabbrica.

## CANALINE - Swimmingpool & Outdoor - R11C

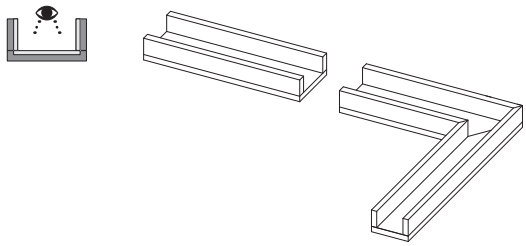

**Canalina**  
Channel  
Caniveaux  
Überlauferinne  
**20x100x8h . 8"x40"x3"h**

□ Nat. Ret. 20mm R11C

**P255**

082652 - Antracite  
082649 - Fumo  
082651 - Ghiaccio  
082650 - Beige

**Canalina Dx/Sx**  
Channel  
Caniveaux  
Überlauferinne  
**20x100x8h . 8"x40"x3"h**

□ Nat. Ret. 20mm R11C

**P271**

082656 DX . 082660 SX - Antracite  
082653 DX . 082657 SX - Fumo  
082655 DX . 082659 SX - Ghiaccio  
082654 DX . 082658 SX - Beige

## CORDOLI - Outdoor - R11C

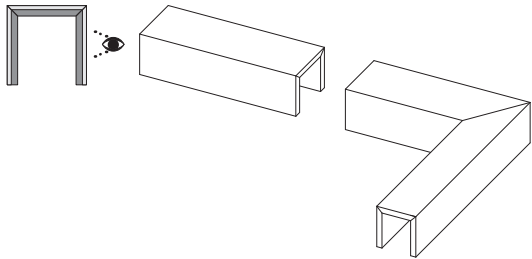

**Cordolo**  
U-Border  
Bordure  
Rand U-Förmig  
**13x100x13h . 5"x40"x5"h**

□ Nat. Ret. 20mm R11C

**P291**

082676 - Antracite  
082673 - Fumo  
082675 - Ghiaccio  
082674 - Beige

**Cordolo Dx/Sx**  
U-Border  
Bordure  
Rand U-Förmig  
**13x100x13h . 5"x40"x5"h**

□ Nat. Ret. 20mm R11C

**P303**

082680 DX . 082684 SX - Antracite  
082677 DX . 082681 SX - Fumo  
082679 DX . 082683 SX - Ghiaccio  
082678 DX . 082682 SX - Beige

## ALZATE - Outdoor - R11C

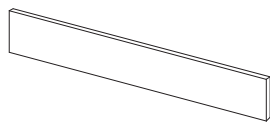

**Alzata**  
Riser  
Contremarche  
Stoßfläche  
**100x20 . 40"x8"**

□ Nat. Ret. 20mm R11C

**P101**

082736 - Antracite  
082733 - Fumo  
082735 - Ghiaccio  
082734 - Beige

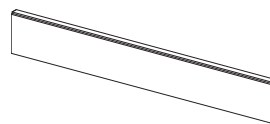

**Alzata con scuretto**  
Riser with shutter  
Contremarche avec cannelure  
Stoßfläche mit Falzbearbeitung  
**100x20 . 40"x8"**

□ Nat. Ret. 20mm R11C

**P151**

082740 - Antracite  
082737 - Fumo  
082739 - Ghiaccio  
082738 - Beige

□ **Naturale e rettificato.** Natural and rectified. Naturel et rectifié. Natur Oberfläche und kalibriert. Natural y rectificado. Натуральный ректифицированный. 天然和拋光。

**ATTENZIONE: Per particolari installazioni potrebbero essere necessari articoli ed accessori specifici non presenti in questo catalogo. Per queste esigenze prego riferirsi direttamente al referente commerciale La Fabbrica.** - N.B. Particular items and accessories not listed in this catalogue may be required for certain laying methods. For these needs, please contact the La Fabbrica sale sales directly.

**ATTENTION :** Pour les installations particulières, certains articles et accessoires particuliers qui ne sont pas indiqués dans ce catalogue pourraient être nécessaires. Dans ces cas-là, nous vous prions de vous référer directement à la référence commerciale La Fabbrica. - **ACHTUNG:** Für besondere Installationen können besondere Artikel oder Sonderzubehör notwendig sein, die nicht im vorliegenden Katalog aufgeführt sind. Wenden Sie sich bitte in diesen Fällen direkt an den Vertrieb von La Fabbrica. - **ATENCIÓN:** para instalaciones particulares podrían requerirse artículos y accesorios específicos que no están presentes en este catálogo. Para tales casos rogamos contactar directamente al representante comercial de La Fabbrica. - **ВНИМАНИЕ:** Для особых применений могут быть необходимы специальные артикулы и аксессуары, не представленные в данном каталоге. По поводу этих вопросов просим вас обращаться непосредственно к менеджеру коммерческого отдела компании La Fabbrica.

# IMBALLI

Package . Emballage . Verpackung . Embalajes . Упаковка . 塗料

FORMATO cm. Size	SPESSORE. Thickness	TIPOLOGIA IMBALLO. Type of packing	LASTRE Slabs	MQ LASTRA Sqm Slab	KG LASTRA Kg Slab	MQ. Sqm	KG Kg	TARA Tare
324x163	12 mm	<b>Cassa Crate</b> 345x175x37	10	5,28	152,47	52,80	1.674	150,00
		<b>Cavalletto in legno Wood A-Frame</b> 330x75x193,5	22			116,16	3.583	229,00
		<b>Cavalletto in ferro Iron A-Frame</b> 330x75x193,5	22			116,16	3.613	259,00
320x160	6 mm	<b>Cassa Crate</b> 345x175x37	14	5,12	74,14	71,68	1.178	140,00
		<b>Cavalletto in legno Wood A-Frame</b> 330x75x193,5	44			225,28	3.472	210,00
160x160	6 mm	<b>Cassa Crate</b> 182,6x173,6x40,4	24	2,56	37,07	61,44	962	71,80
		<b>Cavalletto in legno Wood A-Frame</b> 330x75x193,5	88			225,28	3.472	210,00
240x120	6 mm	<b>Cassa Crate</b> 264x136x40	20	2,88	41,70	57,60	934	100,00
		<b>Cavalletto in legno Wood A-Frame</b> 250x75x153,5	44			126,72	1.993	158,00
120x120	6 mm	<b>Cavalletto in legno Wood A-Frame</b> 250x75x153,5	88	1,44	20,85	126,72	1.993	158,00

FORMATO cm. Size	SPESSORE. Thickness	TIPOLOGIA IMBALLO. Type of packing	PZ. X SCAT. Pieces x Box	MQ. X SCAT. Sqm x Box	KG X SCAT. Weight x Box	SCAT. X PAL. Boxes x Pal.	MQ. X PAL. Sqm x Pal.	KG X PAL. Weight x Pal.
160x80	6 mm	<b>Pallet speciale con sponde Special pallet with sides</b> 168x97x40,9	2	2,56	37,2	15	38,40	648
120x120	6 mm	<b>Pallet speciale con sponde Special pallet with sides</b> 143x123x64,7	2	2,88	41,70	24	69,12	1.057
80x80	6 mm	<b>Europallet 80x120</b>	3	1,92	27,90	40	76,80	1.141
120x60	10 mm	<b>Europallet 80x120</b>	2	1,44	33,41	30	43,20	1.025
60x60	10 mm	<b>Europallet 80x120</b>	3	1,08	24,80	40	43,20	1.012
Mosaico 30x30	6 mm	<b>Europallet 80x120</b>	9	0,81	11,83	60	48,60	595

I pesi riportati in tabella sono indicativi in quanto possono subire leggere variazioni per motivi produttivi. The weights stated in the chart are approximate as some changes may be necessary for production reasons. Les poids figurant dans le tableau sont fournis à titre indicatif car ils peuvent subir de légères variations pour des raisons de production. Die in der Tabelle aufgeführten Gewichte sind nicht bindend, da sie aus Produktionsgründen leichte Änderungen aufweisen können. Los pesos señalados en la tabla son aproximados ya que pueden experimentar ligeras variaciones por motivos productivos. Указанный в таблице вес является приблизительным, так как ввиду производственных потребностей, он может слегка измениться. 表格记载的重量只具有提示意义, 因为可能在生产过程中产生轻微的偏差。

# IMBALLI

Package . Emballage . Verpackung . Embalajes . Упаковка . 塗料

---

**CASSA**  
Crate



Formato lastre / Size slabs  
320x160

**CASSA**  
Crate



Formato lastre / Size slabs  
240x120

**CASSA**  
Crate



Formato lastre / Size slabs  
160x160

**CAVALLETTO IN LEGNO**  
Wood A-Frame



Formato lastre / Size slabs  
320x160  
160x160

**CAVALLETTO IN LEGNO**  
Wood A-Frame



Formato lastre / Size slabs  
240x120  
120x120

**CAVALLETTO IN FERRO**  
Iron A-Frame



Formato lastre / Size slabs  
324x163 12mm

**PALLET SPONDE ALTE**  
High - Sided pallets



Formato lastre / Size slabs  
120x120  
100x100

**PALLET SPONDE ALTE**  
High - Sided pallets



Formato lastre / Size slabs  
160x80

# IMBALLI PEZZI SPECIALI

Packaging for trims . Emballages pièces spéciales . Verpackungen der Formteile . Embalajes de piezas especiales . Упаковка специальных изделий . 包装专用件

FORMATO cm. Size	SPESSORE. Thickness	PZ. X SCAT. Pieces x Box	MQ. X SCAT. Sqm x Box	KG X SCAT. Weight x Box	SCAT. X PAL. Boxes x Pal.	MQ. X PAL. Sqm x Pal.	KG X PAL. Weight x Pal.	CM h PAL. cm h pal.
Pallet speciale con sponde 168x97x40,9h								
Gradino costa retta 160x33x3,2h	6 mm	1	-	9	-	-	-	-
Gradino costa retta dx/sx 160x33x3,2h	6 mm	1	-	10	-	-	-	-
Scuretto 160x20	6 mm	1	-	5	-	-	-	-
Gradino bordo dritto 160x30x4h	6 mm	1	-	8,5	-	-	-	-
Gradino bordo dritto dx/sx 160x30x4h	6 mm	1	-	9,5	-	-	-	-
Simileuro 80x120								
Gradino costa retta 120x33x3,2h	6 mm	2	-	14	-	-	-	-
Gradino costa retta dx/sx 120x33x3,2h	6 mm	1	-	7	-	-	-	-
Gradino costa retta 80x33x3,2h	6 mm	2	-	10	-	-	-	-
Gradino costa retta dx/sx 80x33x3,2h	6 mm	1	-	6	-	-	-	-
Gradino costa retta 120x33x3,2h	10 mm	2	-	22	-	-	-	-
Gradino costa retta dx/sx 120x33x3,2h	10 mm	1	-	11	-	-	-	-
Gradino bordo dritto 120x30x4h	6 mm	2	-	13,5	-	-	-	-
Gradino bordo dritto dx/sx 120x30x4h	6 mm	1	-	7	-	-	-	-
Gradino bordo dritto 80x30x4h	6 mm	2	-	9	-	-	-	-
Gradino bordo dritto dx/sx 80x30x4h	6 mm	1	-	5	-	-	-	-
Gradino bordo dritto 120x30x4h	10 mm	2	-	22	-	-	-	-
Gradino bordo dritto dx/sx 120x30x4h	10 mm	1	-	11	-	-	-	-
Battiscopa 80x8	6 mm	12	-	11,5	-	-	-	-
Battiscopa 120x6,5	10 mm	6	-	11,4	-	-	-	-
Scuretto 80x20	6 mm	1	-	3	-	-	-	-
Scuretto 120x20	10 mm	1	-	12	-	-	-	-

I pesi riportati in tabella sono indicativi in quanto possono subire leggere variazioni per motivi produttivi. The weights stated in the chart are approximate as some changes may be necessary for production reasons. Les poids figurant dans le tableau sont fournis à titre indicatif car ils peuvent subir de légères variations pour des raisons de production. Die in der Tabelle aufgeführten Gewichte sind nicht bindend, da sie aus Produktionsgründen leichte Änderungen aufweisen können. Los pesos señalados en la tabla son aproximados ya que pueden experimentar ligeras variaciones por motivos productivos. Указанный в таблице вес является приблизительным, так как ввиду производственных потребностей, он может слегка измениться. 表格记载的重量只具有提示意义, 因为可能在生产过程中产生轻微的偏差。

Le condizioni generali di vendita, gli schemi ed i consigli di posa sono consultabili sul sito [www.avaceramica.it](http://www.avaceramica.it). The general conditions of sale, together with the laying diagrams and tips are available on the website [www.avaceramica.it](http://www.avaceramica.it). Les conditions générales de vente, les schémas et les conseils de pose peuvent être consultés sur le site [www.avaceramica.it](http://www.avaceramica.it). Die allgemeinen Verkaufsbedingungen, die Schemen und die Verlegeratschläge befinden sich in der Website [www.avaceramica.it](http://www.avaceramica.it). Las condiciones generales de venta, los esquemas y los consejos para la colocación pueden ser consultados en el sitio [www.avaceramica.it](http://www.avaceramica.it). На сайте [www.avaceramica.it](http://www.avaceramica.it) вы можете ознакомиться с общими условиями продажи, схемами и рекомендациями по укладке.

# IMBALLI SKYLINE 100x100

Package . Emballage . Verpackung . Embalajes . Упаковка . 漆料

FORMATO cm. Size	SPESSORE. Thickness	PZ. X SCAT. Pieces x Box	MQ. X SCAT. Sqm x Box	KG X SCAT. Weight x Box	SCAT. X PAL. Boxes x Pal.	MQ. X PAL. Sqm x Pal.	KG X PAL. Weight x Pal.	CM h PAL. cm h pal.
Pallet Speciale con sponde 103x123x60H								
100x100	10 mm	2	2	40,75	24	48	1023	75
100x100 R11	10 mm	2	2	40,75	24	48	1023	75
Pallet 103x103								
100x100 R11	20 mm	1	1	39,85	24	24	982	73
Battiscopa 7x100	10 mm	6	-	9	-	-	-	-
Gradino costa retta 100x33x3,2h	10 mm	2	-	14	-	-	-	-
Gradino costa retta dx/sx 100x33x3,2h	10 mm	1	-	9	-	-	-	-
Gradino costa retta R11 100x33x3,2h	10 mm	2	-	14	-	-	-	-
Gradino costa retta dx/sx R11 100x33x3,2h	10 mm	1	-	9	-	-	-	-
Gradone bordo 50 costa retta R11 100x50	20 mm	1	-	15	-	-	-	-
Gradone bordo 50 costa retta dx/sx R11 100x50	20 mm	1	-	15	-	-	-	-
Gradone bordo 50 costa toro R11 100x50	20 mm	1	-	15	-	-	-	-
Gradone bordo 50 costa toro dx/sx R11 100x50	20 mm	1	-	15	-	-	-	-
Bordo L "A" R11 10x100x10h	20 mm	1	-	6	-	-	-	-
Bordo L "A" dx/sx R11 10x100x10h	20 mm	1	-	6	-	-	-	-
Bordo L "B" R11 10x100x10h	20 mm	1	-	6	-	-	-	-
Bordo L "B" dx/sx R11 10x100x10h	20 mm	1	-	6	-	-	-	-
Canalina R11 20x100x8h	20 mm	1	-	12	-	-	-	-
Canalina dx/sx R11 20x100x8h	20 mm	1	-	12	-	-	-	-

FORMATO cm. Size	SPESSORE. Thickness	PZ. X SCAT. Pieces x Box	MQ. X SCAT. Sqm x Box	KG X SCAT. Weight x Box	SCAT. X PAL. Boxes x Pal.	MQ. X PAL. Sqm x Pal.	KG X PAL. Weight x Pal.	CM h PAL. cm h pal.
Pallet 103x103								
Griglia 20 R11 20x100	20 mm	1	-	8	-	-	-	-
Griglia 20 dx/sx R11 20x100	20 mm	1	-	8	-	-	-	-
Cordolo R11 13x100x13h	20 mm	1	-	15	-	-	-	-
Cordolo dx/sx R11 13x100x13h	20 mm	1	-	15	-	-	-	-
Gradone bordo 50 Grip costa retta R11 100x50	20 mm	1	-	15	-	-	-	-
Gradone bordo 50 Grip costa retta dx/sx R11 100x50	20 mm	1	-	15	-	-	-	-
Gradone bordo 50 grip costa toro R11 100x50	20 mm	1	-	15	-	-	-	-
Gradone bordo 50 grip costa toro dx/sx R11 100x50	20 mm	1	-	15	-	-	-	-
Gradone bordo 50 svasato costa retta R11 100x50	20 mm	1	-	15	-	-	-	-
Gradone bordo 50 svasato costa retta dx/sx R11 100x50	20 mm	1	-	15	-	-	-	-
Gradone bordo 50 svasato costa toro R11 100x50	20 mm	1	-	15	-	-	-	-
Gradone bordo 50 svasato costa toro dx/sx R11 100x50	20 mm	1	-	15	-	-	-	-
Alzata R11 100x20	20 mm	1	-	6	-	-	-	-
Alzata con scuretto R11 100x20	20 mm	1	-	6	-	-	-	-

I pesi riportati in tabella sono indicativi in quanto possono subire leggere variazioni per motivi produttivi. The weights stated in the chart are approximate as some changes may be necessary for production reasons. Les poids figurant dans le tableau sont fournis à titre indicatif car ils peuvent subir de légères variations pour des raisons de production. Die in der Tabelle aufgeführten Gewichte sind nicht bindend, da sie aus Produktionsgründen leichte Änderungen aufweisen können. Los pesos señalados en la tabla son aproximados ya que pueden experimentar ligeras variaciones por motivos productivos. Указанный в таблице вес является приблизительным, так как ввиду производственных потребностей, он может слегка измениться. 表格记载的重量只具有提示意义, 因为可能在生产过程中产生轻微的偏差。

Le condizioni generali di vendita, gli schemi ed i consigli di posa sono consultabili sul sito [www.avaceramica.it](http://www.avaceramica.it). The general conditions of sale, together with the laying diagrams and tips are available on the website [www.avaceramica.it](http://www.avaceramica.it). Les conditions générales de vente, les schémas et les conseils de pose peuvent être consultés sur le site [www.avaceramica.it](http://www.avaceramica.it). Die allgemeinen Verkaufsbedingungen, die Schemen und die Verlegeratschläge befinden sich in der Website [www.avaceramica.it](http://www.avaceramica.it). Las condiciones generales de venta, los esquemas y los consejos para la colocación pueden ser consultados en el sitio [www.avaceramica.it](http://www.avaceramica.it). На сайте [www.avaceramica.it](http://www.avaceramica.it) вы можете ознакомиться с общими условиями продажи, схемами и рекомендациями по укладке.















# CARATTERISTICHE TECNICHE

Technical features . Caracteristiques techniques . Technische Eigenschaften . Caracteristicas tecnicas . Технические характеристики . 技术特点

## LASTRE IN GRES PORCELLANATO PRESSATE A SECCO. Classificazione secondo UNI EN 14411-ISO 13006 - G - Bla (E ≤ 0,5%) UGL

Dry-pressed porcelain stoneware slabs. Product in compliance with UNI EN 14411-ISO 13006 - G - Bla (E ≤ 0,5%) UGL  
 Dalles en grès cérame pressées à sec. Classement selon UNI EN 14411-ISO 13006 - G - Bla (E ≤ 0,5%) UGL  
 Trockengepresste Platten aus Feinsteinzeug. Klassifizierung nach UNI EN 14411-ISO 13006 - G - Bla (E ≤ 0,5%) UGL  
 Planchas en gres porcelánico prensadas en seco. Clasificación según UNI EN 14411-ISO 13006 - G - Bla (E ≤ 0,5%) UGL  
 Керамогранитные плиты сухого прессования. Классификация согласно европейской сертификации UNI EN 14411-ISO 13006 - G - Bla (E ≤ 0,5%) UGL  
 干燥压制瓷质砖。根据UNI EN 14411-ISO 13006 - G - Bla (E ≤ 0,5%) UGL的分类

	<b>CARATTERISTICA</b> Specification Caracteristique Eigenschaft Característica Характеристика 功能	<b>METODO DI PROVA</b> Test methods Methode d'essai Testverfahren Prueba Стандарт испытаний 方法测试	<b>VALORE PRESCRITTO</b> Fixed value Valeur prescrite Vorgeschriebener Wert Valor prescrito Требуемое значение 指引	 EXTRAORDINARY SIZES
	<b>Caratteristiche dimensionali</b> Dimensional characteristics - Dimensions Dimensionale Eigenschaften - Características dimensionales Пространственные характеристики - 尺寸特性	ISO 10545-2		<b>Conforme</b> Compliant Conforme Erfüllt Cumple Соответствует 符合性
	<b>Assorbimento d'acqua</b> Water absorption - Absorption d'eau - Wasseraufnahme Absorción de agua - Водопоглощение - 吸水率	ISO 10545-3	≤ 0,5 %	<b>Conforme</b> Compliant Conforme Erfüllt Cumple Соответствует 符合性
	<b>Resistenza alla flessione</b> Breaking modulus - Resistance a la flexion - Biegefestigkeit Resistencia a la flexión - Прочность на изгиб - 弯曲强度		≥ 35 N/mm <sup>2</sup>	<b>Conforme</b> Compliant Conforme Erfüllt Cumple Соответствует 符合性
	<b>Sforzo di rottura</b> Modulus of rupture - Charge de rupture - Bruchlast Esfuerzo de rotura - Стойкость на изгиб - 断裂应力	ISO 10545-4	≥ 7,5 mm = ≥ 1300 N < 7,5 mm = ≥ 700 N	<b>Conforme</b> Compliant Conforme Erfüllt Cumple Соответствует 符合性
	<b>Resistenza alla abrasione profonda</b> Deep abrasion resistance - Resistance a l'abrasion profonde Beständigkeit gegen Tiefenverschleiß - Resistencia a la abrasión profunda - Устойчивость к глубокому стиранию по - 深层磨损耐性	ISO 10545-6	≤ 175 mm <sup>3</sup>	<b>Conforme</b> Compliant Conforme Erfüllt Cumple Соответствует 符合性
	<b>Coefficiente di dilatazione termica lineare</b> Thermal expansion coefficient - Coefficient de dilatation thermique lineaire Wärmeausdehnungskoeffizient - Coeficiente de dilatación térmica lineal Зкоэффициент теплового линейного расширения - 线性热膨胀系数	ISO 10545-8	<b>Metodo disponibile</b> Available on request - Methode disponible Verfügbares Verfahren - Método disponible Определяется производителем - 可行方法	≤ 7x10 <sup>-6</sup> °C <sup>-1</sup>
	<b>Resistenza agli sbalzi termici</b> Thermal shock resistance - Resistance aux ecarts de temperature Temperaturwechselbeständigkeit - Resistencia a choque térmico Устойчивость к температурным перепадам - 抗热震性	ISO 10545-9	<b>Metodo disponibile</b> Available on request - Methode disponible Verfügbares Verfahren - Método disponible Определяется производителем - 可行方法	<b>Resistenti</b> Resistant Résistants Widerstandsfähig Resiste Устойчивы 耐性
	<b>Resistenza al gelo</b> Frost resistance - Resistance au gel - Frostbeständigkeit Resistencia al hielo - Морозостойкость - 抗冻性	ISO 10545-12	<b>Richiesta</b> Always tested - Exigee - Notwendig - Pedido Требования - 申请	<b>Resistenti</b> Resistant Résistants Widerstandsfähig Resiste Устойчивы 耐性
	<b>Resistenza ai prodotti chimici</b> Chemical resistance - Resistance aux produits chimiques Chemische Beständigkeit - Resistencia a los productos químicos Химическая устойчивость - 耐化学腐蚀			
	<b>Prodotti chimici ad uso domestico ed additivi per piscina</b> Household chemicals and swimming pool water cleansers Produits chimiques courants et additifs pour piscine Chem.Produkte für den Haushaltsgebrauch und Zusatz für Schwimmbäder Productos químicos para uso doméstico y con aditivos para piscina Бытовые химические средства и средства для бассейнов - 家用化学产品和游泳池添加剂	ISO 10545-13	min. UB	<b>Resistenti</b> Resistant Résistants Widerstandsfähig Resiste Устойчивы 耐性
	<b>Acidi ed alcali a bassa concentrazione</b> Acids and low concentration alkalis - Acides et alcali a faible concentration Säuren und Alkali in geringer Konzentration - Ácidos y álcalis en baja concentración Низкоконцентрированные кислоты и щелочи - 低浓度下酸碱度			
	<b>Resistenza alle macchie</b> Stain resistance - Resistance aux taches - Fleckbeständigkeit Resistencia a las manchas - Устойчивость к загрязнению - 耐油污	ISO 10545-14	<b>Metodo disponibile</b> Available on request - Methode disponible Verfügbares Verfahren - Método disponible Определяется производителем - 可行方法	<b>Resistenti</b> Resistant Résistants Widerstandsfähig Resiste Устойчивы 耐性
	<b>Stabilità dei colori alla luce</b> Colour stability to light - Stabilité des couleurs a la lumiere - Lichtechtheit der Farben Estabilidad de los colores - Устойчивость цвета - 光照色牢度	DIN 51094	<b>Metodo disponibile</b> Available on request - Methode disponible Verfügbares Verfahren - Método disponible Определяется производителем - 可行方法	<b>Conforme</b> Compliant Conforme Erfüllt Cumple Соответствует 符合性
	<b>Coefficiente di attrito (scivolosità)</b> Friction coefficient (slipperiness) - Coefficient de frottement (glissance) Reibungskoeffizient (Glätte) - Coeficiente de fricción (deslizabilidad) Коэффициент трения (скользкость) - 摩擦系数 (光滑度)	ANSI A 137.1:2012	≥ 0,42	≥ 0,42 <b>Superficie naturale</b> Natural surface



Consulta il sito [www.avaceramica.it](http://www.avaceramica.it) per vedere gli ultimi aggiornamenti sulla serie.  
Check out our website at [www.avaceramica.it](http://www.avaceramica.it) for the latest updates on the series.  
Consultez le site [www.avaceramica.it](http://www.avaceramica.it) pour connaître les dernières mises à jour de la série.  
Auf der Website [www.avaceramica.it](http://www.avaceramica.it) finden Sie die neuesten Informationen zur Serie.  
Consulta el sitio [www.avaceramica.it](http://www.avaceramica.it) para ver las últimas actualizaciones de la serie.  
Зайдите на сайт [www.avaceramica.it](http://www.avaceramica.it), чтобы увидеть последние новинки этой серии.  
请访问网站[www.avaceramica.it](http://www.avaceramica.it)以查看该系列的最新更新。

Le cromie, le strutture e le grafiche delle piastrelle riprodotte nelle immagini del catalogo potrebbero non corrispondere fedelmente al prodotto industriale.  
The colours, structures, and patterns of the tiles illustrated in the catalogue might not correspond exactly to the actual product.  
Les tonalités, les structures et les graphismes des carreaux reproduits sur les images du catalogue pourraient ne pas correspondre idèlement au produit industriel.  
Es ist möglich, dass die im Katalog abgebildeten Fliesen in Bezug auf Farbton, Struktur und Grafik vom Industrieerzeugnis abweichen.  
Las estructuras, los colores y las gráficas de las baldosas reproducidas en las imágenes del catálogo podrían no coincidir fielmente con el producto industrial.  
Описание оттенков цвета, структура и графическое изображение на плитках, которые напечатаны в каталоге могут не соответствовать действительному промышленному продукту.

Ava Ceramica si riserva di apportare, senza alcun preavviso, le modifiche che riterrà più opportune al fine di migliorare il prodotto.  
Quanto riportato è da considerarsi indicativo e non esaustivo in riferimento ai colori e alle caratteristiche estetiche dei prodotti.

Ava Ceramica reserves the right to make any changes it deems fit in order to improve the product, without prior notice.  
All images are provided for illustrative purposes only and other colours and aesthetic features are available.

Ava Ceramica se réserve le droit d'apporter, sans préavis, les modifications qu'elle jugera opportunes afin d'améliorer le produit.  
Les informations ci-dessus sont fournies à titre indicatif et elles ne sont pas contraignantes en ce qui concerne les couleurs et les caractéristiques esthétiques des produits.  
Die Firma Ava Ceramica behält sich vor, ohne jegliche vorherige Ankündigung jene Änderungen vorzunehmen, die sie zur Verbesserung des Produktes für angebracht hält.  
Die Angaben sind bezüglich der Farben und ästhetischen Eigenschaften der Produkte als Richtwerte und nicht als vollständig anzusehen.

Ava Ceramica se reserva la posibilidad de introducir, sin obligación de aviso previo, las modificaciones que considere más indicadas para mejorar el producto.  
Las cualidades del material presentado deben considerarse de modo genérico, no siendo exhaustivas en cuanto a los colores y a las características estéticas de los productos.  
Ava Ceramica оставляет за собой право на внесение без предварительного уведомления изменений, которые она считает целесообразными для улучшения продукции.  
Приведенные указания должны считаться ориентировочными и не исчерпывающими в том, что касается цветов и эстетических характеристик продукции.

## CERTIFICAZIONI DI PRODOTTO

Product certification . Certification de produit . Produkt Zertifizierungen . Certificaciones de producto . Сертификация . 产品认证



Certificazione obbligatoria per l'esportazione in Cina.  
Certification mandatory for export to China.  
Certification obligatoire pour l'exportation en Chine.  
Für den Export nach China obligatorische Zertifizierung.  
Certificación obligatoria para la exportación a China.  
Обязательная сертификация для Экспорта в Китай.



Azienda Certificata  
Certified Company



Per conoscere le serie certificate consultare il sito [www.certiquality.it](http://www.certiquality.it)  
Here the website where you can find our certified series: [www.certiquality.it](http://www.certiquality.it)

 **Tutte le lastre sono certificabili MOCA.**  
All the slabs can be MOCA-certified. Toutes les dalles sont certifiées MOCA. Alle Platten sind nach MOCA zertifizierbar. Todas las planchas pueden ser certificadas MOCA.  
Все плиты могут иметь сертификат MOCA. 所有面板均可通過MOCA認證。



**La Fabbrica S.p.A.**  
Via Emilia Ponente, 925  
48014 Castel Bolognese (RA) Italy  
Tel. +39 0546 - 659911  
Fax +39 0546 - 656223  
[www.avaceramica.it](http://www.avaceramica.it)  
[www.lafabbrica.it](http://www.lafabbrica.it)

A company part of



Follow us

